

64000

**HP64000
Logic Development
System**

**Model 64214A
6809 Emulator
Control Board**



**HEWLETT
PACKARD**

CERTIFICATION

Hewlett-Packard Company certifies that this product met its published specifications at the time of shipment from the factory. Hewlett-Packard further certifies that its calibration measurements are traceable to the United States National Bureau of Standards, to the extent allowed by the Bureau's calibration facility, and to the calibration facilities of other International Standards Organization members.

WARRANTY

This Hewlett-Packard system product is warranted against defects in materials and workmanship for a period of 90 days from date of installation. During the warranty period, HP will, at its options, either repair or replace products which prove to be defective.

Warranty service of this product will be performed at Buyer's facility at no charge within HP service travel areas. Outside HP service travel areas, warranty service will be performed at Buyer's facility only upon HP's prior agreement and Buyer shall pay HP's round trip travel expenses. In all other cases, products must be returned to a service facility designated by HP.

For products returned to HP for warranty service. Buyer shall prepay shipping charges to HP and HP shall pay shipping charges to return the product to Buyer. However, Buyer shall pay all shipping charges, duties, and taxes for products returned to HP from another country.

HP warrants that its software and firmware designated by HP for use with an instrument will execute its programming instructions when properly installed on that instrument. HP does not warrant that the operation of the instrument, or software, or firmware will be uninterrupted or error free.

LIMITATION OF WARRANTY

The foregoing warranty shall not apply to defects resulting from improper or inadequate maintenance by Buyer, Buyer-supplied software or interfacing, unauthorized modification or misuse, operation outside of the environmental specifications for the product, or improper site preparation or maintenance.

NO OTHER WARRANTY IS EXPRESSED OR IMPLIED. HP SPECIFICALLY DISCLAIMS THE IMPLIED WARRANTIES OF MERCHANTABILITY AND FITNESS FOR A PARTICULAR PURPOSE.

EXCLUSIVE REMEDIES

THE REMEDIES PROVIDED HEREIN ARE BUYER'S SOLE AND EXCLUSIVE REMEDIES. HP SHALL NOT BE LIABLE FOR ANY DIRECT, INDIRECT, SPECIAL, INCIDENTAL, OR CONSEQUENTIAL DAMAGES, WHETHER BASED ON CONTRACT, TORT, OR ANY OTHER LEGAL THEORY.

ASSISTANCE

Product maintenance agreements and other customer assistance agreements are available for Hewlett-Packard products.

For any assistance, contact your nearest Hewlett-Packard Sales and Service Office. Addresses are provided at the back of this manual.

MODEL 64214A
6809 EMULATOR CONTROL BOARD

REPAIR NUMBERS

This manual applies directly to Emulator Control
Boards with repair numbers prefixed 2250A.
For additional information about repair numbers
see Section I, paragraph 1-3.

© COPYRIGHT HEWLETT-PACKARD COMPANY/LOGIC SYSTEMS DIVISION 1983
COLORADO SPRINGS, COLORADO, USA

ALL RIGHTS RESERVED

Manual Part No. 64214-90901
Microfiche Part No. 64214-90801

PRINTED: MARCH 1983
UPDATED: JUNE 1983

SAFETY SUMMARY

The following general safety precautions must be observed during all phases of operation, service, and repair of this instrument. Failure to comply with these precautions or with specific warnings elsewhere in this manual violates safety standards of design, manufacture, and intended use of the instrument. Hewlett-Packard Company assumes no liability for the customer's failure to comply with these requirements.

GROUND THE INSTRUMENT.

To minimize shock hazard, the instrument chassis and cabinet must be connected to an electrical ground. The instrument is equipped with a three-conductor ac power cable. The power cable must either be plugged into an approved three-contact electrical outlet or used with a three-contact to two-contact adapter with the grounding wire (green) firmly connected to an electrical ground (safety ground) at the power outlet. The power jack and mating plug of the power cable meet International Electrotechnical Commission (IEC) safety standards.

DO NOT OPERATE IN AN EXPLOSIVE ATMOSPHERE.

Do not operate the instrument in the presence of flammable gases or fumes. Operation of any electrical instrument in such an environment constitutes a definite safety hazard.

KEEP AWAY FROM LIVE CIRCUITS.

Operating personnel must not remove instrument covers. Component replacement and internal adjustments must be made by qualified maintenance personnel. Do not replace components with power cable connected. Under certain conditions, dangerous voltages may exist even with the power cable removed. To avoid injuries, always disconnect power and discharge circuits before touching them.

DO NOT SERVICE OR ADJUST ALONE.

Do not attempt internal service or adjustment unless another person, capable of rendering first aid and resuscitation, is present.

DO NOT SUBSTITUTE PARTS OR MODIFY INSTRUMENT.

Because of the danger of introducing additional hazards, do not install substitute parts or perform any unauthorized modification of the instrument. Return the instrument to a Hewlett-Packard Sales and Service Office for service and repair to ensure that safety features are maintained.

DANGEROUS PROCEDURE WARNINGS.

Warnings, such as the example below, precede potentially dangerous procedures throughout this manual. Instructions contained in the warnings must be followed.

WARNING

**Dangerous voltages, capable of causing death, are present in this instrument.
Use extreme caution when handling, testing, and adjusting.**

Table of Contents

Section	Page
I	GENERAL INFORMATION.....1-1
	1-1. Introduction.....1-1
	1-4. Instruments Covered by this Manual.....1-1
	1-9. Description.....1-2
	1-11. Accessories Supplied.....1-2
	1-13. Additional Equipment Required.....1-2
	1-15. Power Supply Loading.....1-2
II	INSTALLATION2-1
	2-1. Introduction.....2-1
	2-3. Initial Inspection.....2-1
	2-5. Installation And Removal.....2-1
	2-7. Operating Environment.....2-4
	2-10. Storage And Shipment Environment.....2-4
	2-12. Packaging.....2-4
III	OPERATION.....3-1
	3-1. Introduction.....3-1
IV	PERFORMANCE VERIFICATION4-1
	4-1. Introduction.....4-1
	4-3. Performance Verification.....4-1
	4-7. Performance Tests.....4-3
	4-9. Test Error Counts.....4-3
	4-10. Status Display.....4-3
	4-11. Processor Control Test-Part 1.....4-4
	4-13. Reset Test.....4-4
	4-14. Background Test.....4-4
	4-15. Release Test.....4-4
	4-16. Run Test.....4-4
	4-17. Processor Control Test-Part 2.....4-4
	4-18. Background Interrupt Test.....4-4
	4-19. Illegal Opcode Test.....4-5
	4-20. Slow Clock Test.....4-5
	4-21. Emulation Memory Test.....4-5
	4-22. Emulation Bus Test.....4-5
	4-24. Data Test.....4-5
	4-25. Address Test.....4-6

Table of Contents (Cont'd)

4-26.	Foreground Test.....	4-6
	4-28. Release Test.....	4-6
	4-29. Run Test.....	4-6
	4-30. Processor Break Test.....	4-6
	4-31. Illegal Memory Reference Test.....	4-6
	4-32. Last Opcode Address.....	4-6
	4-33. Last Memory Address.....	4-7
	4-34. SISR,XFER.....	4-7
4-35.	Analysis Stimulus.....	4-7
4-38.	Memory and Analysis Board PV.....	4-7
V	ADJUSTMENTS.....	5-1
	5-1. Introduction.....	5-1
	5-3. Safety Requirements.....	5-1
	5-5. Equipment Required.....	5-1
	5-7. Adjustments.....	5-1
	5-10. Adjustment Procedures.....	5-2
	5-12. HMAV Delay Adjustment.....	5-3
	5-14. LWDV Delay Adjustment.....	5-4
VI	REPLACEABLE PARTS.....	6-1
	6-1. Introduction.....	6-1
	6-3. Blue Stripe Program.....	6-1
	6-5. Reference Designators and Abbreviations.....	6-1
	6-7. Replaceable Parts List.....	6-1
	6-9. Ordering Information.....	6-2
	6-12. Direct Mail Order System.....	6-2
VII	MANUAL CHANGES.....	7-1
	7-1. Introduction.....	7-1
	7-3. Manual Changes.....	7-1
VIII	THEORY AND SCHEMATICS.....	8-1
	8-1. Introduction.....	8-1
	8-3. Safety.....	8-1
	8-5. Component Locator.....	8-1
	8-7. Schematic Diagrams.....	8-1
	8-9. Mnemonics.....	8-1

List of Tables

Table	Title	Page
1-1.	Power Supply Requirements.....	1-2
6-1.	Reference Designators and Abbreviations.....	6-2
6-2.	Replaceable Parts.....	6-4
7-1.	Manual Changes.....	7-1
8-1.	Mnemonics.....	8-2
8-2.	Logic Symbols.....	8-10
8-3.	Schematic Diagram Notes.....	8-13

List of Illustrations

Figure	Title	Page
1-1.	6809 Emulation Subsystem.....	1-0
2-1.	Recommended Card Cage Configuration.....	2-2
4-1.	Awaiting Command Display.....	4-8
4-2.	Option Map.....	4-8
4-3.	Emulator PV Menu.....	4-9
4-4.	Processor Control Test-Part 1 Displays.....	4-10
4-5.	Processor Control test-Part 2 Displays.....	4-11
4-6.	Emulation Bus Test Displays.....	4-12
4-7.	Foreground Test Displays.....	4-13
4-8.	Memory and Analysis PV Displays.....	4-14
5-1.	Adjustment Locations.....	5-2
5-2.	HMAV Adjustment Waveforms.....	5-3
5-3.	LWDV Adjustment Waveforms.....	5-4
6-1.	6809 Emulator Control Card.....	6-3
8-1.	6089 Emulator Control Board, Component Locator.....	8-14
8-2.	Service Sheet 1. Data and Address Buffers.....	8-15
8-3.	Service Sheet 2. Mainframe Interface Logic.....	8-16
8-4.	Service Sheet 3. Background Memory Controller.....	8-17
8-5.	Service Sheet 4. Jam and Foreground Memory Control.....	8-18
8-6.	Service Sheet 5. Background Memory.....	8-19
8-7.	Service Sheet 6. Mainframe/Emulator Synchronizer.....	8-20
8-8.	Service Sheet 7. Analysis Data and Pin Status.....	8-21

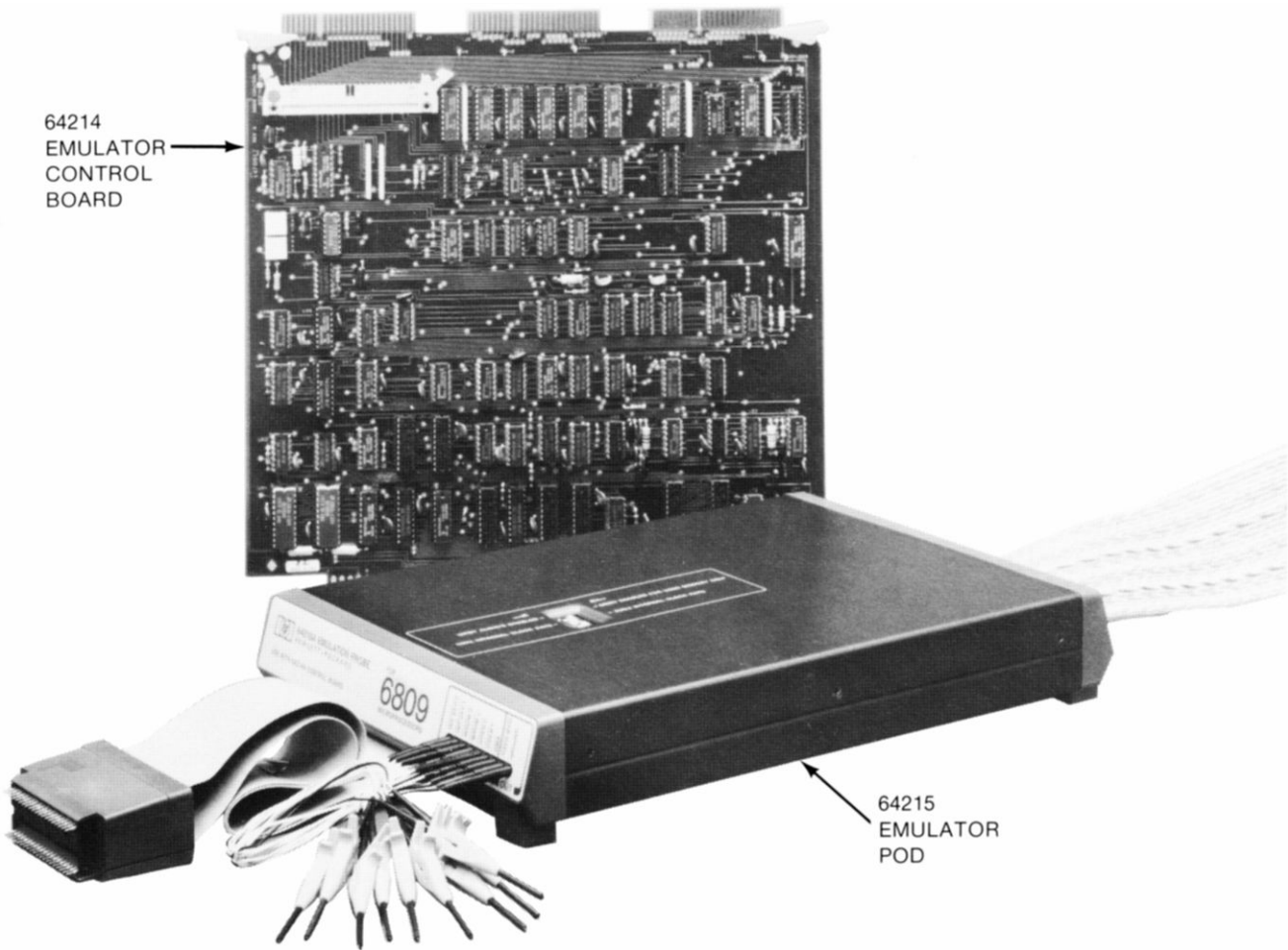


Figure 1-1. 6809 Emulation Subsystem

SECTION I

GENERAL INFORMATION

1-1. INTRODUCTION.

1-2. This Service Manual contains information required to install, test and service the Model 64214A 6809 Emulator Control Board.

1-3. This manual is organized with eight sections: Section I provides a brief physical and functional description. Section II outlines installation and removal. Section III, Operation, refers to another manual which contains operations information. Section IV, Performance Verification, discusses the Performance Verification tests. Section V describes Adjustments. Section VI lists replaceable parts. Section VII explains backdating needed to make this manual applicable to older units. Section VIII contains the component locator, and the schematic diagrams.

1-4. INSTRUMENTS COVERED BY THIS MANUAL.

1-5. Printed on each 64214A 6809 Emulator Control Board is the repair number. The repair number is in two parts, in the form 0000A00000. The first four digits and the letter are the repair prefix and the last five are the suffix. The prefix is the same for all identical boards. The suffix is assigned sequentially and is different for each board. The contents of this manual apply to boards with the repair number prefixes listed under REPAIR NUMBERS on the title page.

1-6. Any board manufactured after the printing of this manual may have a repair prefix that is not listed on the title page. This unlisted repair number prefix indicates that the board may be different from those described in this manual. Updating the manual for this newer board is accomplished by a manual changes supplement. The supplement contains "change information" that explains how to adapt this manual for the newer board.

1-7. In addition to change information, the supplement contains information for correcting errors in this manual. To keep this manual as current as possible, Hewlett-Packard recommends that you periodically request the latest manual changes supplement. The supplement for this manual is identified with the manual print date and the part number, which both appear on the manual title page. Complimentary copies of the supplement are available from Hewlett-Packard.

1-8. For information concerning a repair number prefix that is not listed on the title page or in the manual changes supplement, contact your nearest Hewlett-Packard Sales/Service Office.

General Information-Model 64214A

1-9. DESCRIPTION.

1-10. The Model 64214A 6809 Emulator Control Board is a single printed circuit board which installs in the 64000 mainframe. This board provides emulation control for the 6809 Emulator Subsystem. The 6809 Emulator Card requires a 6809 Emulator Pod, Model 64215A, to perform software development and in-circuit emulation.

1-11. ACCESSORIES SUPPLIED.

1-12. Supplied with the Emulator Control Board are two 8120-3351 bus cables which are required to connect the board to the Model 64151A Emulation Memory Controller option. The installation of these cables is discussed in Section II.

1-13. ADDITIONAL EQUIPMENT REQUIRED.

1-14. The Model 64214A must be plugged into the 64000 mainframe and connected to an emulation pod to have a minimum emulation subsystem.

1-15. POWER SUPPLY LOADING.

1-16. The power requirements of the Emulator Control Board when configured with the emulator pod are listed in Table 1-1.

Table 1-1. Power Supply Requirements

	64214A	64215A	TOTAL
+5 V	1.5 A	3.4 A	4.9 A
-5 V		Approx. 2ma	

No other voltages are required.

SECTION II

INSTALLATION

2-1. INTRODUCTION.

2-2. This section contains information required to install the Model 64214A in the Model 64000 mainframe. Also included are the initial inspection procedures, damage claim information, and the operating, storage, and shipment environmental considerations.

2-3. INITIAL INSPECTION.

2-4. Inspect the shipping container for damage. If the shipping container or cushioning material is damaged, it should be kept until contents of the shipment have been checked mechanically and electrically. Procedures for checking performance are provided in Section IV of this manual. If the contents are not complete, if there is mechanical damage or defect, or if the board does not pass the performance tests, notify the carrier as well as Hewlett-Packard Sales/Service office. Keep the shipping materials for carriers inspection. The Hewlett-Packard Sales/Service office will arrange for repair or replacement at HP option without waiting for claim settlement.

2-5. INSTALLATION AND REMOVAL.

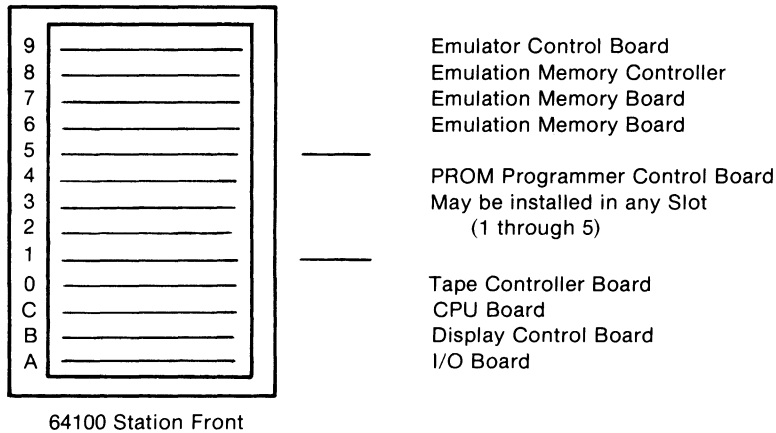
2-6. Figure 2-1 shows a top view of the 64100A mainframe card cage and the recommended position for the Emulator Control Board and for the Static RAM Controller Board, Static RAM Boards, and the Internal Analysis Boards which are optional. The recommended slot for the 64214A is the rearmost position. This maximizes the free cable length to the emulator pod.

WARNING

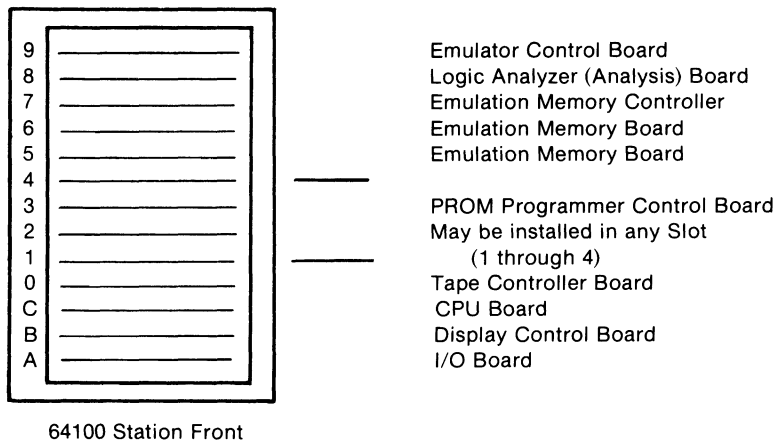
To prevent personal injury, refer to the safety requirements listed in the mainframe manual before installing this option.

CAUTION

The 64214A Emulator Control Board must be installed and removed with the 64000 power turned off. Damage to the unit may otherwise result.



A. EMULATION AND MEMORY



B. EMULATION/ANALYSIS AND MEMORY

Figure 2-1. Recommended Card Cage Configuration

- 2-6. To install the 64214A, proceed as follows:
- a. Turn 64100A power OFF.
 - b. Loosen the two hold down screws and remove the card cage access cover.
 - c. Connect the selected emulator pod to the Emulator Control Board prior to the installation of the board in the card cage. This is done to simplify the connection of the the multi-conductor pod bus cables to the board. Two multi-colored ribbon cables are used to connect the pod to the Emulator Control Board. One cable terminates in a female card-edge connector, the other terminates in a female socket-type connector. Pin 1 is indicated by a triangle molded into the body of each connector. The mating connectors for the cable connectors are located at the top left corner of the board as viewed from the component side. Pin 1 of the card-edge connector (J1) is indicated by a "1" etched into the board. Pin 1 of the connector block located directly below J1 (J4) is indicated by a triangle molded into the connector block. The connector block and the mating female connector on the cable have matching colored dots on their surfaces. The connector block is a latching type connector. Before installing the cable connector into the connector block insure that the latching tips are open (spread toward the outside edges of the board). Connect the card-edge connectors first, then connect the socket-type connector to the connector block. Push the socket-type connector into the connector block until the latching tips snap over the top of the connector.
 - d. Grasp the board by the extractor levers located at the top of the board. Be very careful not to dislodge the cables. Hold the board with the component side toward the front of the development station and the card-edge connector labeled P1 toward the bottom of the card cage. Insert the board into the selected card slot guide rails, make sure P1 and the motherboard connector are aligned, and push the board down until seated firmly in the connector.
 - e. The bus cables supplied with the Emulator Control Board are used to connect to the optional Emulation Memory Controller. The bus cables are keyed so that they will seat on the edge connector in only one position.
 - f. Stack the emulator pod cables flat across one of the cable rests at the back of the development station.
 - g. Reinstall the card cage access cover and tighten the two screws.

2-7. To remove the 64214A, reverse the installation procedure.

2-8. If the optional Emulation Memory Controller is installed, connect the emulation bus cables as follows. Align pin one of each ribbon cable connector, indicated by the dark stripe on the side of the cable and by a colored dot on the connector, with pin one on the card edge connectors J2 and J3 of each board, also indicated by a colored dot. Press the connector on until it seats firmly on the edge connector.

2-9. OPERATING ENVIRONMENT.

2-10. The 64214A may be operated in environments within the following limits:

Temperature.....0° to +40° C
Humidity.....5% to 80% relative humidity
Altitude.....4 600 m (15 000 ft)

It should be protected from temperature extremes which cause condensation within the unit.

2-11. STORAGE AND SHIPMENT ENVIRONMENT.

2-12. The 64214A may be stored or shipped within the following limits:

Temperature.....-40° C to +75° C
Humidity.....5% to 80% relative humidity
Altitude.....15 300 m (50 000 ft)

2-13. PACKAGING.

2-14. ORIGINAL PACKAGING. Containers identical to those used in factory packaging are available through Hewlett-Packard offices.

2-15. OTHER PACKAGING. The following general instructions should be used for repacking with commercially available materials:

- a. Wrap the Emulator Control Board in heavy paper or plastic.
- b. Use a strong shipping container. A double-wall shipping container of 350 pound test material is adequate.
- c. Use a layer of shock absorbing material 70- to 100 mm (3- to 4 inch) thick around all sides of the board to provide firm cushioning and to prevent movement inside the container.
- d. Seal shipping container securely.
- e. Mark shipping container FRAGILE to ensure careful handling.
- f. In any correspondence, refer to the board by model number and full repair number.

SECTION III

OPERATION

Operation of the 6809 Emulation Subsystem is beyond the scope of this manual, please refer to the 6809 Operation Manuals for operating instructions.

SECTION IV

PERFORMANCE VERIFICATION

4-1. INTRODUCTION.

4-2. This section describes the Performance Verification for the 6809 Emulation Control Card. The scope of the Performance Verification is to detect problems at the board level only. Board level troubleshooting is in support of the Blue Stripe Program.

4-3. For convenience, the figures for the Performance Verification are grouped together at the end of this section.

4-4. RUNNING 64214A EMULATION PERFORMANCE VERIFICATION.

4-5. The Performance Verification (P.V.) for the 64214A 6809 Control Board is a subsection of the Option Test P.V. The Option Test P.V. tests all possible option modules that can be configured within the expansion slots of the Mainframe.

The option_test P.V. can either be run with a 64000 development station configured in a network arrangement (hard disk based); or it may be run from a 64000 station in a stand-alone configuration (mini disk based). When running the option_test performance verification on a Model 64214A Control Board from a stand-alone 64000 configuration, the following modules must be present on the current local disk system:

FLOPPY_OP_SYS OPTION_TEST PV_EMUL_6809

4-6. To test the 64214A, proceed as follows.

- a. With the operating system initialized and awaiting a command, press the softkey option_test followed by a return.

option_test RETURN

- b. The CRT will now display a directory of the installed option boards and their slot numbers. (Figure 4-2). Locate the 6809 Controller and enter the card slot number. For example, in Figure 4-2 the 64214A is in slot 9. Therefore, enter:

9 RETURN

At this point you may receive a prompt to select a slot number for one of the other option boards loaded in the mainframe. This prompt will be displayed when more than one board is loaded which performs the same function. For example, if two analysis boards are loaded in the mainframe the display will prompt:

Select analysis board for test:9

- c. A menu will now appear which lists the tests available to exercise the emulator (figure 4-3). This is the Emulator PV Menu (refer to Figure 4-3). The following softkeys will appear at the bottom of the display.

<end>	Returns the user to the option test card slot listing
<disp_test>	Advances the user to the detailed view of the mapper control test; that is, the test execution display.
<print>	Copies the display to the system line printer (if one is attached)

- d. Press the <disp_test> softkey. This will advance the P.V. to the Control Board test execution display (refer to Figure 4-4). The following softkeys are listed at the bottom of the display:

<start>	Begins execution of the tests listed.
<exit_test>	Returns the user to the Mapper Control Test overview display described previously.
<print>	Copies the display to the system line printer (if one is attached).

- e. To initiate testing of the 6809 Control Card, press the <start> softkey. The key will be highlighted in inverse video on the display and test execution will proceed. The <cycle> softkey is used to cycle through the tests executing each test once per pass. When the <cycle> key is used, the display maintains a count of the number of times each test is executed (#Test) and the number of failures detected (#Fail). If all tests pass, testing can be terminated as described in the next paragraph. However, if any failures occur, refer to the description of the Control Board Test in the following sections.

- f. You can end testing of the 64214A in one of two ways:

1. The <start> softkey may be pressed. The test will terminate at the end of the current test cycle and the start softkey on the display will return to normal video. To completely exit the performance verification from this point, press the <exit_test> softkey. This returns you to the Performance Verification Menu display. Press the <end> softkey while in this display. This returns you to the option_test card slot listing, at which point the <end> softkey can be pressed to exit the performance verification software.

2. The <exit_test> softkey may be pressed. The test will terminate at the end of the current test cycle and the display will be returned to the Performance Verification Menu display. At this point, you may press the <end> softkey, returning the display to the option_test card slot listing level. When the <end> softkey is pressed at this point, the option_test performance verification is completely exited and the display is returned to the "Awaiting command" status.

4-7. PERFORMANCE TESTS.

4-8. Five groups of tests are included in the 6809 PV: the Processor Control Tests, Parts 1 and 2, the Emulation Bus Tests, the Foreground Tests, and the Analysis Stimulus Tests. Each segment of a test excercises a selected function of the emulator. The tests should be run in the sequence they are given to ensure that the results are valid. The following paragraphs provide a brief description of each test.

4-9. TEST ERROR COUNTS. The performance test summary displays include two columns labeled # Fail and # Test. The # Fail column increments for each pass of a test in which an error is detected. The # Test column increments for each pass of a test which is executed.

4-10. STATUS DISPLAY. The Processor Control Tests and the Foreground Tests use a status display to report the results of certain tests. This display reports the results of comparisons of the expected test results with the actual test results. It is not a display of the current status of these bits. These bits are numbered to correspond to the numbered bits of the Emulator Status register 5100.

5 4 3 2 1 0 9 8 7 6 5 4 3 2 1 0	Status= 0 0 0 0 0 0 0 0 0 0 0 0 0 0 0 0	
		Status Error Indicated
- - - - - - - - - - - - - - - 1		RESET
- - - - - - - - - - - - - - - 1 -		BA
- - - - - - - - - - - - - - - 1 - -		XFER
- - - - - - - - - - - - - - - 1 - - -		MRDY
- - - - - - - - - - - - - - - 1 - - - -		HALT
- - - - - - - - - - - - - - - 1 - - - - -		BREQ
- - - - - - - - - - - - - - - 1 - - - - - -		SISR
- - - - - - - - - - - - - - - 1 - - - - - - -		HISR
- - - - - - - - - - - - - - - 1 - - - - - - - -		BKG INT
- - - - - - - - - - - - - - - 1 - - - - - - - - -		MEM BRK
- - - - - - - - - - - - - - - 1 - - - - - - - - - -		ILLOP
- - - - - - - - - - - - - - - 1 - - - - - - - - - - -		BKG
- - - - - - - - - - - - - - - 1 - - - - - - - - - - - -		CLOCK
1 1 1 -		JAM INTERRUPT VECTOR (A3,A2,A1)

4-11. PROCESSOR CONTROL TEST-PART 1.

4-12. The Processor Control Tests-Part 1 check the ability of the mainframe processor in the development station to control the emulator. Each of the major control functions is tested and the background memory is checked. Tests included in the Processor Control-Part 1 tests are; the Reset Test, the Background Test, the Release Test, and the Run Test. A failure detected by any of these tests indicates a problem in the emulator control board or the pod Processor board except for failures in HISR or SISR status. HISR and SISR status errors indicate the pod Synchronizer Board may have failed.

4-13. RESET TEST. The Reset Test performs a preliminary check of the status reporting capability of the emulator. The mainframe processor resets the emulator and then reads the status reported back. The test results are then compared to the expected results.

4-14. BACKGROUND TEST. This test checks the background memory. In the Reset Test segment, the mainframe processor writes a data pattern to the background memory, while the emulation processor is held reset. The data is then read back and compared to the expected results. In the Not Reset Test the identical memory test is performed again while the emulation processor is executing a short program. The test results are displayed as the address and the data received as a result of the memory test.

NOTE

When the Background Test fails, the results of the following tests may not be valid.

4-15. RELEASE TEST. The release test verifies that the emulator can be released to run programs in the background memory. A short program which modifies the contents of a memory location in the background memory is loaded into the background memory. The emulator is released to run the program and then the location is checked to verify that the memory contents of that location were changed. The error indication from this test is a status word equal to the data read from the memory location.

4-16. RUN TEST. A short program is loaded into the background memory and executed. The program is then modified causing a branch to a memory test. Failures occur when the background program is not successfully modified during the program run. The test returns the address error from the memory test. The status display contains the address which failed in the memory test.

4-17. PROCESSOR CONTROL TEST-PART 2.

The Processor Control Test-Part 2 tests check other emulator functions. These tests include the Background Interrupt, the Illegal Opcode Test, the Slow Clock Test, and the Emulation Memory Test. The emulation memory test is unavailable if optional emulation memory is not installed.

4-18. BACKGROUND INTERRUPT TEST. The background interrupt test attempts to execute a single step command. If a background interrupt does not occur a failure is reported. A failure of this test indicates a problem in the control board.

4-19. ILLEGAL OPCODE TEST. An illegal opcode is loaded into the background memory and an attempt is made to execute the illegal instruction code with the illegal opcode detector enabled and disabled. The status display shown below is returned when a failure is detected.

Status = 1 1 1

- 1 - - Illegal Opcode Masking Failure.
Emulator Control Board problem indicated.
- 1 - Illegal Opcode Detector failure.
Pod Synchronizer or Control Board problem indicated.
- - 1 Illegal Opcode Detector did not clear.
Emulator Control Board problem indicated.

4-20. SLOW CLOCK TEST. A CWAIT instruction is executed from the background memory. In approximately one-half second the SLOW CLOCK status bit should set. Failures are reported as shown below.

Status = 1 1

- 1 - Slow Clock Detector Failure
- 1 Clear Failed

Failures indicate a problem on the pod Synchronizer board or the Emulator Control Board.

4-21. EMULATION MEMORY TEST. The Emulation Memory Test checks the emulation RAM and the associated control, address and data lines. Two test segments are used: a Data Test and an Address Test. To begin the test the emulator is reset by the mainframe processor. The mainframe processor then writes data to the memory and reads it back. The test is then repeated with a short program executing in background. Failures detected during the Reset Test indicate a problem on the Emulation Memory Controller Board. Failures detected during the Not Reset Test indicate a problem on the Emulator Control Board or the Emulation Memory Controller Board.

4-22. EMULATION BUS TEST.

4-23. The Emulation Bus Test verifies the operation of the emulation bus address and data lines. The emulation bus is used to connect the Emulator Control Board to the optional Memory Control and Logic Analyzer Boards. This test requires the successful completion of the Processor Control Tests for both the Emulator Control Board and the Static Memory Control Board PV. The Emulation Bus Test consists of two subtests: the Data Test, and the Address Test.

4-24. DATA TEST. The mainframe processor tests two blocks of emulation memory for this test. In the first part of the test the memory is loaded through the memory control board and read through the emulator control board. In the second part of the test the inverse pattern is written to memory through the emulation control board and read back through the memory control board. A failure indicates a problem in the emulator control or memory control boards, or in the the memory bus cables.

Performance Verification--Model 64214A

4-25. ADDRESS TEST. The Address Test operates similarly to the data test except a pattern of addresses is used and the data lines are assumed to be good. Any failure detected is reported as an address error and indicates the same sources for errors.

4-26. FOREGROUND TEST.

4-27. The Foreground Test checks the ability to emulate in foreground memory. The Foreground Test consists of seven subtests: the Release Test, the Run Test, the Processor Break Test, the Illegal Memory Reference Test, the Last Opcode Address Test, the Last Memory Address Test, and the SISR, XFER Test. A description of each tests is provided below.

4-28. RELEASE TEST. The Release Test loads a program into emulation memory and releases the emulation processor to execute the program. The program is designed to modify a specific memory location. The host processor waits a suitable amount of time and then checks to see that the memory location has been modified. A failure detected by this test indicates a problem on the pod Processor Board, the Emulator Control Board or the pod Synchronizer Board. The error indication from this test is a status word equal to the data read from the memory location.

4-29. RUN TEST. For the Run Test, a program is loaded into emulation memory and the emulation processor is released to execute the program. The host processor monitors the emulator status during the program run. Status errors detected by the host processor indicate a problem on the pod Processor Board, Emulator Control Board or the pod Synchronizer Board.

4-30. PROCESSOR BREAK TEST. For the Processor Break Test a program is loaded into emulation memory and the emulation processor is released to execute the program. The host processor then tries to break the program run. The contents of the PC register and the status of the NMI occurrence bit are checked. An error indicates a problem in the pod Processor Board, Emulator Control Board or the pod Synchronizer Board.

4-31. ILLEGAL MEMORY REFERENCE TEST. In the Illegal Memory Reference Test, the mainframe maps blocks of the available memory into RAM, ROM and Illegal Memory space. The emulation processor then executes programs which attempt to reference these areas of memory. The host processor monitors the operation and checks that the proper break and illegal reference status bits are reported. Failures detected by this test indicate a problem in the Memory Control Board or the Emulation Control Board.

4-32. LAST OPCODE ADDRESS. For the Last Opcode Address test the emulation processor executes programs which cause bit patterns to be stored in the last opcode register on the Emulator Control board. The host processor checks the address stored against the expected results. Errors indicate a problem on the Control Board or the pod Processor Board.

4-33. LAST MEMORY ADDRESS. This test is identical to the Last Opcode Address test except that the patterns are stored in the last memory address register.

4-34. SISR, XFER. The SISR, XFER test checks the operation of the pod Synchronizer Board. The host monitors the operation of the SISR and XFER control lines while the emulation processor is running a test program. Any error detected indicates a problem on the pod Synchronizer Board or the Emulator Control Board.

4-35. ANALYSIS STIMULUS.

4-36. If an internal analysis board is connected to the emulation bus, it will monitor data operations on the emulation bus. The analyzer may be used to collect or store data. There may be more than one internal analyzer connected to the emulation bus and will be indicated, to the user, by the option_test card cage menu. The Analysis Stimulus test checks to make sure that the analyzer is monitoring data operations correctly. If no analyzer board is present in the mainframe, the performance verification screen will tell the user that the analysis tests cannot be performed. For failures that occur during the analysis tests, refer to the appropriate analyzer manual for test details.

4-38. MEMORY AND ANALYSIS BOARD PV.

4-39. The Emulation Bus and Foreground Tests of the memory controller board PV, and the Emulation Stimulus Test of the analysis board PV, cannot be used with the 6809 Emulation Subsystem. Figure 4-9 contains the PV Selection Menu Displays for the PV of both boards. The message "Select Slot #9 for Emulation Bus and Foreground Tests" appears in the memory board PV. The message "Select Slot #9 for Emulation Stimulus Tests" appears in the analysis board PV display.

```
I/O BUS CONFIGURATION
ADRS  DEVICE
0     13037 DISC CONTROLLER
      UNIT 0 7906 DISC MEMORY LU=0 LU=1
1     2631 PRINTER
2     7910 DISC MEMORY          LU=2
5     THIS 64000

STATUS: Awaiting Command _____ 14:18
-
```

Figure 4-1. Awaiting Command Display

```
HP 64000 Option Performance Verification
Card # ID # Module
-----
7     0200H Static Memory Controller
8     0100H Analysis
9     0005H 6809 Emulator

STATUS: Awaiting test selection _____ 14:18
-
end <SLOT #> _____ print
```

Figure 4-2. Option Map


```
Emulation Performance Verification
6809 Emulator in card slot # 9
Static Memory Controller in card slot # 7 Analysis in card slot # 8

Test                                     # Fail # Test
Processor Control - part 1                0      12
              - part 2                   0      0
Emulation Bus                             0      0
Foreground                                 0      0
Analysis stimulus                          0      0

STATUS: Awaiting test selection _____ 14:18
-
  end   cycle  next test  start  _____ print
```

Figure 4-3. Emulator PV Menu

```
Emulation Performance Verification
6809 Emulator in card slot # 9
Static Memory Controller in card slot # 7 Analysis in card slot # 8

Test                                     # Fail # Test
Processor Control - part 1                0      12
-- part 2                                0       0
Emulation Bus                            0       0
Foreground                                0       0
Analysis stimulus                         0       0

STATUS: Awaiting test selection _____ 14:18
-
  end   cycle  next test  start  _____ print
```

Entry Display

```
Processor Control Test - part 1
6809 Emulator in card slot # 9
Static Memory Controller in card slot # 7 Analysis in card slot # 8

Test                                     # Fail # Test
Reset                                   OK                0       2
Background  Reset      OK                0
           Not Reset  OK                0
Release     OK          OK                0
Run         OK          OK                0

STATUS: Test in progress _____ 14:18
-
  end   _____ print
```

Test Summary

Figure 4-4. Processor Control Test-Part 1 Displays

```

Emulation Performance Verification
6809 Emulator in card slot # 9
Static Memory Controller in card slot # 7 Analysis in card slot # 8

Test                                     # Fail # Test
Processor Control - part 1                0      12
- part 2                                  0      8
Emulation Bus                             0       0
Foreground                                 0       0
Analysis stimulus                          0       0

STATUS: Awaiting test selection _____ 14:18
-
end cycle next test start _____ print
    
```

Entry Display

```

Processor Control Test - part 2
6809 Emulator in card slot # 9
Static Memory Controller in card slot # 7 Analysis in card slot # 8

Test                                     # Fail # Test
Background interrupt      OK                0       1
Illegal opcode            OK                0
Slow clock                OK                0
Emulation memory Reset   OK                0
                          Not Reset OK      0

STATUS: Test in progress _____ 14:18
-
end _____ print
    
```

Test Summary

Figure 4-5. Processor Control Test-Part 2 Displays

```
Emulation Performance Verification
6809 Emulator in card slot # 9
Static Memory Controller in card slot # 7 Analysis in card slot # 8

Test                                     # Fail # Test
Processor Control - part 1                0      12
      - part 2                            0      0
Emulation Bus                             0      0
Foreground                                0      0
Analysis stimulus                          0      0

STATUS: Awaiting test selection _____ 14:18
-----
end      cycle  next test  start      _____ print
```

Entry Display

```
Emulation Bus Test
6809 Emulator in card slot # 9
Static Memory Controller in card slot # 7 Analysis in card slot # 8

Test                                     # Fail # Test
Address      OK                           0      1
Data        Read  OK                       0
           Write OK                       0

STATUS: Test in progress _____ 14:18
-----
end      _____ print
```

Test Summary
Figure 4-6. Emulation Bus Test Displays

```

Emulation Performance Verification
6809 Emulator in card slot # 9
Static Memory Controller in card slot # 7 Analysis in card slot # 8

Test                                     # Fail # Test
Processor Control - part 1                0      12
      - part 2                            0      0
Emulation Bus                             0      0
Foreground                                0      0
Analysis stimulus                          0      0

STATUS: Awaiting test selection _____ 14:18
-
  end   cycle  next test  start  _____ print
    
```

Entry Display

```

Foreground Test
6809 Emulator in card slot # 9
Static Memory Controller in card slot # 7 Analysis in card slot # 8

Test                                     # Fail # Test
Release          OK                          0      1
Run              OK                          0
Processor break  OK                          0
Illegal reference OK                          0
Last opcode address OK                       0
Last memory address OK                       0
Sisr, xfer      OK                          0

STATUS: test in progress _____ 14:18
-
  end   _____ print
    
```

Test Summary
Figure 4-7. Foreground Test Displays

```
Memory Performance Verification

Static Memory Controller in card slot # 7
Select slot # 9 for Emulation Bus and Foreground tests
Test                                     # Fail # Test
Processor Control                        0      0
Emulation Bus                            0      0
Foreground                                0      0

STATUS: Invalid Processor _____ 14:18
-
  end   cycle  next_test  start  _____ print
```

Entry Display

```
Analysis Performance Verification

Analysis in card slot # 8
Select slot # 9 for Emulator stimulus tests
Static Memory Controller in card slot # 7
Test                                     # Fail # Test
Calibrate                                N/A     0
Halt mode                                 0      0
Run mode                                  0      0
Emulator stimulus                         0      0
Counter (approx. 2 min.)                  0      0

STATUS: Invalid Processor _____ 14:18
-
  end   cycle  next_test  start  _____ print
```

Test Summary
Figure 4-8. Memory and Analysis PV Displays

SECTION V

ADJUSTMENTS

5-1. INTRODUCTION.

5-2. This section provides the adjustment procedures required to return the emulation subsystem to peak operating condition following repairs. The assemblies provided under the Blue Stripe Program for system repair have had these adjustments performed at the factory and should not require readjustment. Included in this section are the adjustment location illustration, the adjustment procedures and the waveforms.

5-3. SAFETY REQUIREMENTS.

5-4. Although this instrument has been designed in accordance with international safety standards, general safety precautions must be observed during all phases of operation, service, and repair of the instrument. Failure to comply with the precautions listed in the Safety Summary at the front of this manual, or with the specific warnings given throughout the manual, could result in serious injury or death. Service adjustments should be performed only by qualified service personnel.

5-5. EQUIPMENT REQUIRED.

5-6. The equipment required to perform the adjustments given in this section is limited to a dual-channel oscilloscope Hewlett-Packard Model 1743 or equivalent. This instrument is a dual channel unit with a delayed sweep, has a bandwidth of 100 MHz, and is capable of time interval measurements with 0.1 nsec resolution and 0.5 nsec accuracy.

5-7. ADJUSTMENTS.

5-8. The adjustment procedures provided in this section are not interrelated and may be performed separately. R-12 is used to adjust the HMAV delay, and R-11 is used to adjust the LWDV delay. The location of the potentiometers and U19 is shown in figure 5-1.

5-9. These adjustments are made at the factory and should not require readjustment. When repairs are made to the board, these adjustments should be checked. For best results allow the instrument to warm up for 15 minutes before making any adjustments.

5-10. ADJUSTMENT PROCEDURES.

WARNING

Adjustment procedures are performed with the power supplied to the instrument and should be performed only by trained service personnel who are aware of the hazards involved (for example, fire and electrical shock).

5-11. For these adjustments the following preliminary steps should be performed:

- a. Turn 64000 development station power OFF.
- b. Install the extender board (PN 64100-66510) into the option slot to be used for the control board.
- c. Install the control board using the procedure given in Section II, Installation, but inserting the control board into the extender board instead of the motherboard.

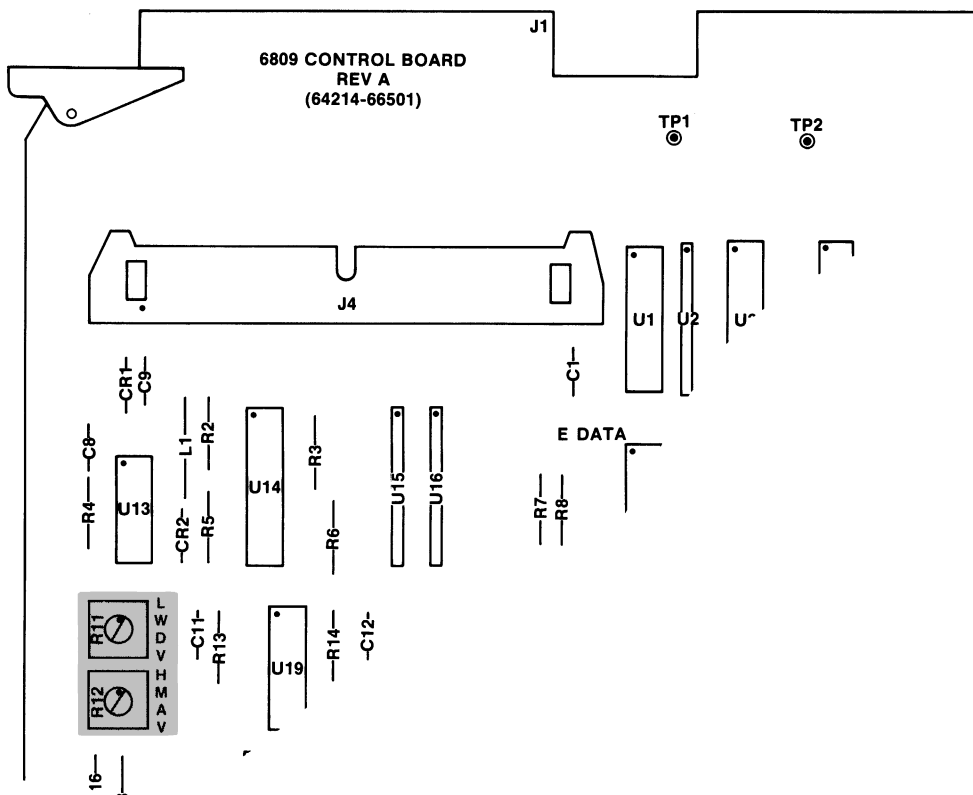


Figure 5-1. Adjustment Locations

5-12. HMAV DELAY ADJUSTMENT.

5-13. The HMAV delay is set using the following procedure:

- a. Connect the oscilloscope channel A to U19 pin 4.
- b. Connect the oscilloscope channel B to U19 pin 6.
- c. Adjust the oscilloscope to trigger on the rising edge of the pulse on channel A and adjust the horizontal sweep for at least a 100 nsec sweep.
- d. Adjust R-12 until the wave form shown below is obtained.

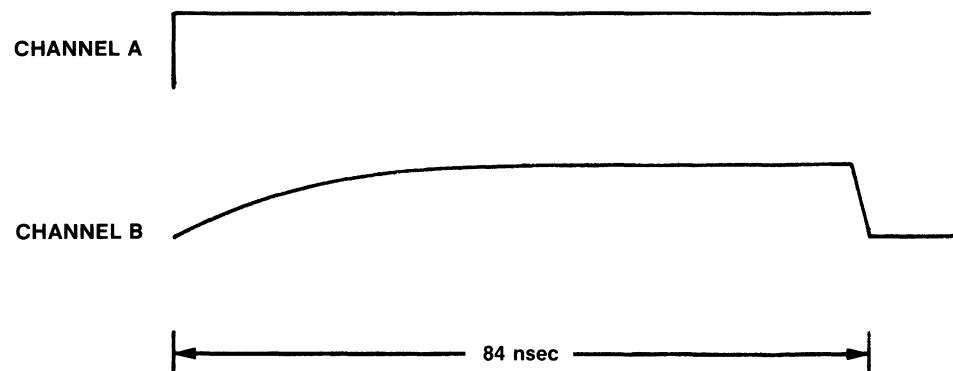


Figure 5-2. HMAV Adjustment Waveforms

5-14. LWDV DELAY ADJUSTMENT.

5-15. The LWDV delay adjustments is set using the following procedure:

- a. Connect the oscilloscope channel A to U19 pin 12.
- b. Connect the oscilloscope channel B to U19 pin 10.
- c. Adjust the oscilloscope to trigger on the rising edge of the pulse on channel A and adjust the horizontal sweep for a sweep of 200 nsec minimum.
- d. Adjust R-11 until the waveform shown below is obtained.

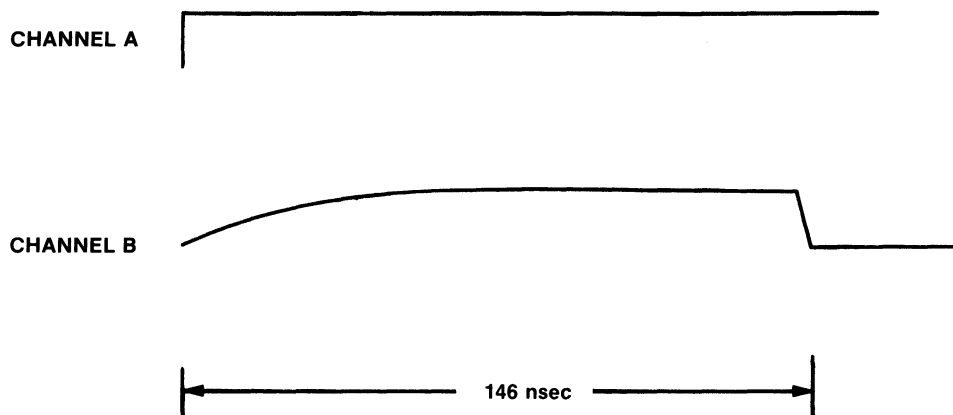


Figure 5-3. LWDV Adjustment Waveforms

SECTION VI

REPLACEABLE PARTS

6-1. INTRODUCTION.

6-2. This section contains information needed to order replacement parts. Section 6-3 explains the Blue Stripe Program for replaceable assemblies. Table 6-1 lists reference designators and abbreviations used throughout the manual. Table 6-2 lists all Emulator Control Board replaceable parts in assembly/reference designator order.

6-3. BLUE STRIPE PROGRAM.

6-4. The Blue Stripe Program offers factory repaired and tested replacement boards, on an exchange basis only. Exchange assemblies carry a part number different from brand new assemblies and are available at a reduced cost. Emulator Control Board exchange assemblies, Part Number 64214-69501 are available through the Hewlett-Packard Corporate Parts Center. New boards are ordered using Part Number 64214-66501.

6-5. REFERENCE DESIGNATORS AND ABBREVIATIONS.

6-6. Table 6-1 lists the reference designations and abbreviations used in the parts list, schematics and throughout the manual. Reference designations are presented in upper case only. Abbreviations are presented in upper case only in the parts list. Abbreviations with both upper and lower case letters are used in the schematics and other parts of the manual. This results in two forms of the abbreviation. Table 6-1 lists only the upper case form of each.

6-7. REPLACEABLE PARTS LIST.

6-8. Table 6-2 is a preliminary list of replaceable parts. The board components are listed by HP Part Number. The information given for each part consists of the following:

- a. The Reference Designator and Manufacturers Part Number.
- b. The Hewlett-Packard part number.
- c. The quantity in the assembly.

Replaceable Parts--Model 64214A

6-9. ORDERING INFORMATION.

6-10. To order a part listed in the replaceable parts table, quote the Hewlett-Packard part number and indicate the quantity required to the nearest Hewlett-Packard sales/service office.

6-11. To order a part that is not listed in the replaceable parts table include the instrument model number, instrument repair number, the description and function of the part, and the number of parts required. Address the order to the nearest Hewlett-Packard sales/service office.

6-12. DIRECT MAIL ORDER SYSTEM.

6-13. Within the USA Hewlett-Packard can supply parts through the direct mail order system. The advantages of using the system are as follows:

- a. Direct ordering and shipment from the Hewlett-Packard parts center in Mountain View, California.
- b. No minimum amount on any mail order (there is a minimum order amount for parts ordered through a local HP office when the order requires billing and invoicing).
- c. Prepaid transportation (there is a small handling charge for each order).
- d. No-invoices. To receive these advantages, a check or money order must accompany each order.

6-14. Mail-order forms and specific ordering information are available through your local HP office. Addresses and phone numbers are provided at the back of this manual.

Table 6-1. Reference Designators and Abbreviations

REFERENCE DESIGNATORS							
A	= assembly	F	= fuse	MP	= mechanical part	U	= integrated circuit
B	= motor	FL	= filter	P	= plug	V	= vacuum, tube, neon bulb, photocell, etc
BT	= battery	IC	= integrated circuit	Q	= transistor	VR	= voltage regulator
C	= capacitor	J	= jack	R	= resistor	W	= cable
CP	= coupler	K	= relay	RT	= thermistor	X	= socket
CR	= diode	L	= inductor	S	= switch	Y	= crystal
DL	= delay line	LS	= loud speaker	T	= transformer	Z	= tuned cavity network
DS	= device signaling (lamp)	M	= meter	TB	= terminal board		
E	= misc electronic part	MK	= microphone	TP	= test point		
ABBREVIATIONS							
A	= amperes	H	= henries	N/O	= normally open	RMO	= rack mount only
AFC	= automatic frequency control	HDW	= hardware	NOM	= nominal	RMS	= root-mean square
AMPL	= amplifier	HEX	= hexagonal	NPO	= negative positive zero (zero temperature coefficient)	RWV	= reverse working voltage
BFO	= beat frequency oscillator	HG	= mercury	NPN	= negative-positive-negative	S-B	= slow-blow
BE CU	= beryllium copper	HR	= hour(s)	NRFR	= not recommended for field replacement	SCR	= screw
BH	= binder head	HZ	= hertz	NSR	= not separately replaceable	SE	= selenium
BP	= bandpass					SECT	= section(s)
BRS	= brass	IF	= intermediate freq			SEMICON	= semiconductor
BWO	= backward wave oscillator	IMPG	= impregnated	OBD	= order by description	SI	= silicon
		INCD	= incandescent	OH	= oval head	SIL	= silver
CCW	= counter-clockwise	INCL	= include(s)	OX	= oxide	SL	= slide
CER	= ceramic	INS	= insulation(ed)			SPG	= spring
CMO	= cabinet mount only	INT	= internal			SPL	= special
COEF	= coefficient	K	= kilo=1000			SST	= stainless steel
COM	= common			P	= peak	SR	= split ring
COMP	= composition	LH	= left hand	PC	= printed circuit	STL	= steel
COMPL	= complete	LIN	= linear taper	PF	= picofarads= 10 ⁻¹² farads	TA	= tantalum
CONN	= connector	LK WASH	= lock washer	PH BRZ	= phosphor bronze	TD	= time delay
CP	= cadmium plate	LOG	= logarithmic taper	PHL	= phillips	TGL	= toggle
CRT	= cathode-ray tube	LPF	= low pass filter	PIV	= peak inverse voltage	THD	= thread
CW	= clockwise			PNP	= positive-negative-positive	TI	= titanium
		M	= milli=10 ⁻³	P/O	= part of	TOL	= tolerance
DEPC	= deposited carbon	MEG	= meg=10 ⁶	POLY	= polystyrene	TRIM	= trimmer
DR	= drive	MET FLM	= metal film	PORC	= porcelain	TWT	= traveling wave tube
		MET OX	= metallic oxide			U	= micro=10 ⁻⁶
ELECT	= electrolytic	MFR	= manufacturer	POT	= potentiometer	VAR	= variable
ENCAP	= encapsulated	MHZ	= mega hertz	PP	= peak-to-peak	VDCW	= dc working volts
EXT	= external	MINAT	= miniature	PT	= point		
		MOM	= momentary	PWV	= peak working voltage	W/	= with
F	= farads	MOS	= metal oxide substrate			W	= watts
FH	= flat head	MTG	= mounting	RECT	= rectifier	WIV	= working inverse voltage
FIL H	= fillister head	MY	= "mylar"	RF	= radio frequency	WW	= wirewound
FXD	= fixed	N	= nano (10 ⁻⁹)	RH	= round head or right hand	W/O	= without
		N/C	= normally closed				
G	= giga (10 ⁹)	NE	= neon				
GE	= germanium	NI PL	= nickel plate				
GL	= glass						
GRD	= ground(ed)						

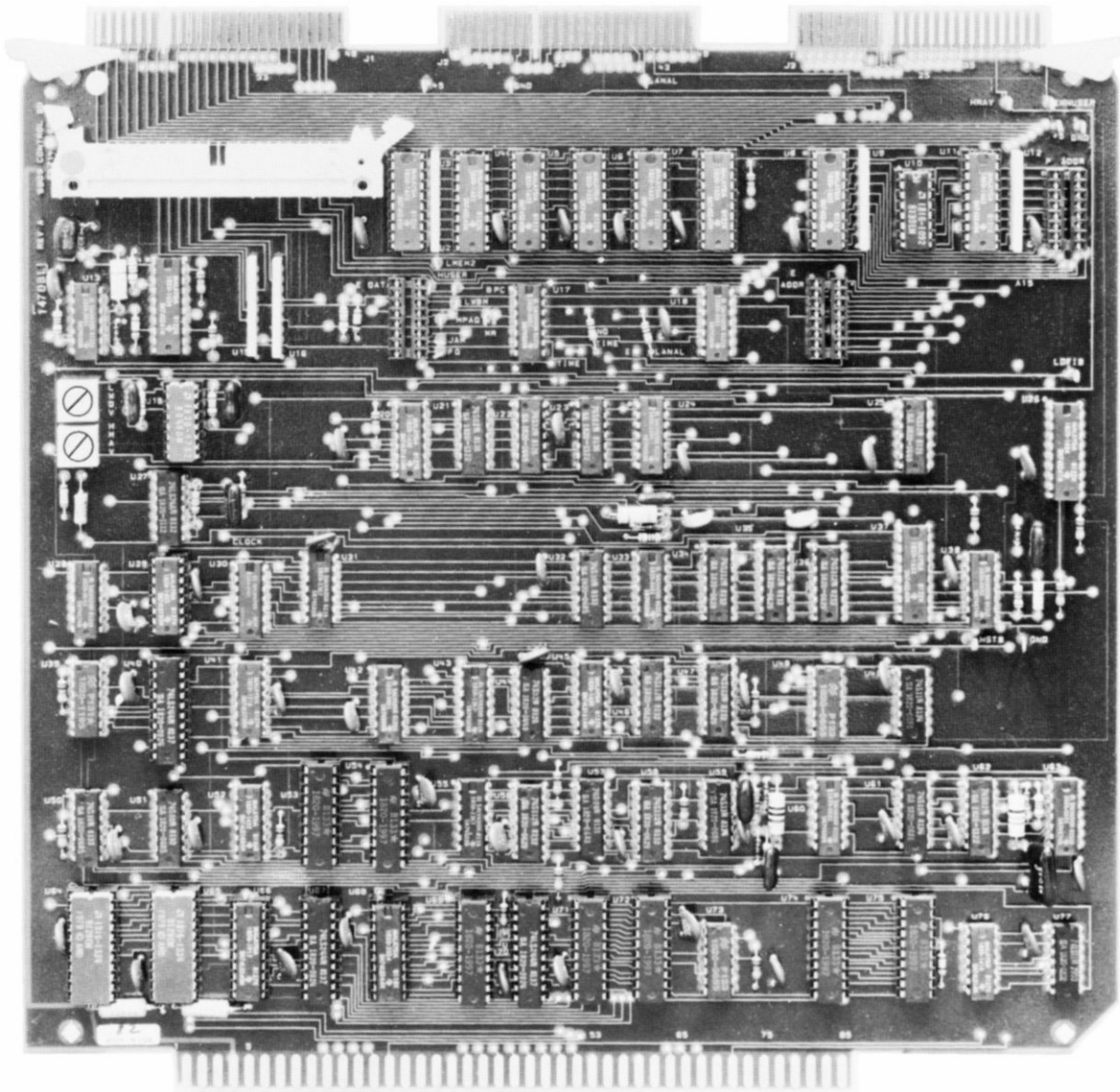


Figure 6-1. 6809 Emulator Control Card

Table 6-2. Replaceable Parts

Reference Designator	Description	Part Number	Quantity
A1	BD ASY-CTL 6809	64214-66502	1
W1,W2	CABLE-MEMORY	8120-3351	2
	A1		
C19,41	CF MI 330P 500V	0140-0207	2
C1-8,10,13-17,21,22,24-40, 42,44,45,47-56	CF CE .01UF 100V	0160-2055	46
C9,20,43	CF MI 100P 300V	0160-2204	3
C23	CF MI 360PF 300V	0160-2209	1
C46	CF MI 510P 300V	0160-2211	1
C11,12	CF MI 27P 300V	0160-2306	2
C18	CF TA 4.7UF 10V	0180-0309	1
C57,58	CF TA 15U 20V	0180-1746	2
TP1-19	TERM-TEST POINT	0360-0535	19
R1,3,6,15,18,20,21,23-29	RF .2500 1000 10	0684-1021	21
R17,R40	RF .12MF 316 1	0698-3444	1
R2,7	RF .12MF 221 1	0757-0282	2
R9,10	RF .12MF 10 1	0757-0346	2
R30	RF .12MF 121 1	0757-0403	1
R5,8,37	RF .12MF 274 1	0757-0409	3
R4,19,22,31,32	RF .12MF 511 1	0757-0416	5
R13	RF .12MF 4.75K 1	0757-0437	1
R16	RF .12MF 243K 1	0757-0474	1
R14	RF .12MF 1.47K 1	0757-1094	1
U10,19,29	SOCKET-IC 16 PIN	1200-0607	6
U64,65	SOCKET 22 PIN	1200-0612	2
U1,3-8,11,40,53,54 66-72,74,75	SOCKET-IC 20 PIN	1200-0639	20
MP1	POLARIZING KEY	1251-5595	2
J4	CONN-50 P MREJT	1251-5653	1
MP2	PIN-GRV .062X .250	1480-0116	2
U2,9,12,15,16	RES NET SPEC SIP	1810-0430	5
U10	IC-27LS00N RAM	1816-1092	1
U64,65	IC 93422 RAM	1816-1334	2
U34-36,46,47,56,58	IC-74S112	1820-0629	7
U48,73	IC 7425N	1820-0655	2
U13,17,18,24,33,42,60	IC 74S00	1820-0681	7
U57	IC 74S04	1820-0683	1
U32,50,51	IC 74S10	1820-0685	3
U49,59,61	IC 74S11	1820-0686	3
U28,38,63	IC 74S74	1820-0693	3
U30	IC 7412N	1820-0907	1
U27	IC 74LS74AN SLT	1820-1112	1
U39	IC 74LS175N SLT	1820-1195	1
U77	IC-74LS10	1820-1202	1
U41	IC 74LS128	1820-1216	1
U23,21,62	IC 74S02	1820-1322	3
U31,43,55	IC 74S08	1820-1367	3
U76	IC 74LS14	1820-1416	1
U29	IC 74LS123	1820-1423	1
U20,45	IC 74LS161	1820-1430	2
U52	IC 74LS163	1820-1432	1
U22,25,44	IC 74S32	1820-1449	3
U14,26	IC 74S241	1820-1624	2
U1,3-8,11,37	IC 74S240N	1820-1633	9
U19	IC 26S02	1820-1782	1

Replaceable Parts--Model 64214A

Table 6-2. Replaceable Parts (Cont'd)

Reference Designator	Description	Part Number	Quantity
U66	IC 74LS 240N	1820-1917	1
U53,54,69,71,72,74,75	IC 74LS374N SLT	1820-1997	7
U40,67,68,70	IC 74LS244N SLT	1820-2024	4
CR1-8	DIODE SCHOTTKY	1901-0535	8
R12	RV CMT 2K .5W	2100-0567	1
R11	RV CMT 5K .5W	2100-3252	1
MP3	EXTRACTOR-PC BD	64214-85001	1
MP4	EXTRACTOR-PC BD	64214-85002	1
MP5	LABEL-WARNING	7120-6492	1
MP6	LABEL-RED DOT	7124-0269	AR
MP7	LABEL-YELLOW DOT	7124-0270	AR
L5	LFMO 15.0UH 40MC	9100-1620	1
L3	LFMO .22UH 510MC	9100-2251	1
L1,L2	LFMO 8.2UH 50MC	9140-0105	2
L4	LFMO 10UH 45MC	9140-0114	1

SECTION VII

MANUAL CHANGES

7-1. INTRODUCTION.

7-2. This section contains information required to backdate or update this manual for a specific instrument.

7-3. MANUAL CHANGES.

7-4. This manual applies directly to the instrument having the same serial prefix shown on the manual title page. If the serial prefix of the instrument is not the same as the one on the title page, find your serial prefix in Table 7-1. and make the changes to the manual that are listed for that serial prefix. When making changes listed in Table 7-1, make the change with the highest number first. Example: if backdating changes 1,2,and 3 are required for your serial prefix, do Change 3 first, then Change 2, and finally Change 1.

7-5. If the serial prefix of your instrument is not listed either on the title page or in Table 7-1, refer to an enclosed manual changes sheet for updating information. Also, if a MANUAL CHANGES sheet is supplied, make all indicated ERRATA changes.

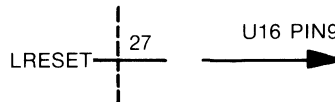
Table 7-1. Manual Changes

64214A

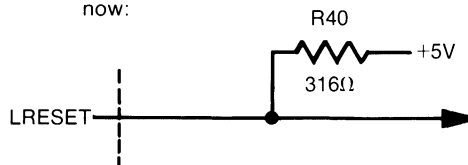
Serial Prefix	Make Changes
2150A	1

CHANGE 1

was:



now:



SECTION VIII

THEORY AND SCHEMATICS

8-1. INTRODUCTION.

8-2. This section contains information for servicing the Emulator Control Board. Figure 8-1 is a component locator for the board and figures 8-2 through 8-8 are the schematic.

8-3. SAFETY.

8-4. Read the safety warnings at the front of this book and at the front of the mainframe service manual, the service overview manual and the applicable emulator subsystem manual before servicing this Emulator Control Board.

8-5. COMPONENT LOCATOR.

8-6. The component locator provides the reference designators and locations for each replaceable part contained on the printed circuit assembly. The component locator is provided as a fold-out drawing.

8-7. SCHEMATIC DIAGRAMS.

8-8. The schematic diagrams are presented as fold-out sheets located at the end of this section. A list of standard reference designators and abbreviations is presented in Section VI of this manual. Table 8-1 describes the techniques used in the development of the logic symbols. Table 8-2 describes the development of the schematic symbols.

8-9. MNEMONICS.

8-10. Signals in the Model 64214A have been assigned mnemonics which describe the active state and function of the signal lines. A prefix letter (H,L,P or N) indicates the active state of the signal and the remaining letters indicate its function. An "H" prefix indicates that the function is active in the high state; an "L" prefix indicates that it is active in the low state. For devices that are edge sensitive the prefix "P" indicates that the function is active on the positive going edge; the prefix "N" indicates that the device is active on the negative going edge. These mnemonics are listed in table 8-1.

Table 8-1. Mnemonics

TO/FROM EMULATION POD

A0-15	EMULATOR ADDRESS 0-15. Buffered emulation processor address bus.
DMA	DIRECT MEMORY ACCESS. This input signal to the emulator indicates that the user system is performing a DMA transfer.
DMA/BREQ	DIRECT MEMORY ACCESS/BUS REQUEST. This signal generated by U7A is applied to the emulation processor.
ED0-ED7	EMULATION DATA 0-7. Eight bit wide bidirectional emulation data bus from U39 and U41.
EFG	EMULATION FOREGROUND. Goes high whenever a reference is made to memory addresses mapped as foreground memory. Also an interschematic mnemonic.
EINT/EXT	EMULATION INTERNAL/EXTERNAL CLOCK. Clock select signal sent to the pod from the mainframe processor through the control register to operate U36 and U37. When high, the internal oscillator in the pod is enabled, when low, the target system clock is used. Also an inter-schematic mnemonic.
ELBKG	EMULATION LOW BACKGROUND. Goes low when the background controller enters the background state.
ELREFREQ	EMULATION LOW REFRESH REQUEST. Not used with current memory and analysis boards. When used, would provide for stopping the emulator processor for an emulation memory refresh cycle. Held high.
EPFG	EMULATION PRE-FOREGROUND. Goes high to indicate the background controller is going to change from background to foreground mode.
EVMA	EMULATION VALID MEMORY ADDRESS. Modified HVMA from the emulator processor. Goes high to indicate a valid memory address is present on the address bus (A0-15)
FETCH	This status line, generated on the synchronizer board, is high for the first instruction cycle and stays high until the first operand fetch or write cycle.
FORCENMI	FORCE NMI. A signal generated by the mainframe BPC to force a non-maskable interrupt when the emulator leaves background.
FORCEUSER	FORCE USER. Forceuser inhibits HMAV (high Memory Available) which inhibits the emulator memory and forces user memory access.
R/W	READ/WRITE. The emulation processor sets this line high for read operations and low for write operations.

Table 8-1. Mnemonics (Cont'd)

HFETCH	HIGH FETCH. High Fetch 1. This status signal, generated on the synchronizer board, is high only during the first instruction cycle.
HISR	HARDWARE INTERRUPT SERVICE ROUTINE. This signal, generated on the Synchronizer board, signals the analyzer that a hardware interrupt has occurred and also signals the end of the subroutine.
INTRV	INTERRUPT VECTOR. This signal, generated on the synchronizer board, gates BS and BA to generate INTRV which is high when an interrupt vector fetch is occurring.
LBA	LOW BUS AVAILABLE. Buffered HBA from emulation processor. Goes high to indicate the address bus is available as during a processor halt or a wait state.
LDEFIB	LOW DEFIBRILLATION. Goes low when the mainframe processor resets the emulation processor in the pod.
LHALT	LOW HALT. A microprocessor pin status register bit from the pod emulator processor HALT pin.
LRESET	LOW RESET. Emulation reset line. Goes low whenever a reset is applied to the emulation processor.
SISR	SOFTWARE INTERRUPT SERVICE ROUTINE. This status line is generated on the Synchronizer Board to signal the analyzer that a software interrupt vector fetch is occurring.
Q/E	Clock input required by the 6309 processor. These inputs may be taken from the user system or may be generated on the Processor Board.
TRANSFER	TRANSFER. This status signal generated on the synchronizer board signals a transfer of control from the emulator to the target system.

Table 8-1. Mnemonics (Cont'd)

MAINFRAME INTERFACE

LA0-7	LOW ADDRESS 0-7. The low-order eight bits from the mainframe processor address bus. Also an Inter-schematic mnemonic.
LA8	LOW ADDRESS 8. The ninth bit from the mainframe address bus. Also an Inter-schematic mnemonic.
LDO-7	LOW DATA 0-7. Bidirectional 8-bit data bus. Lower half of 16-bit communications path from the mainframe processor to the emulator control card. Also an Inter-schematic mnemonic.
LD8-15	LOW DATA 8-15. Bidirectional 8-bit data bus. Upper half of the 16-bit communications path from the mainframe processor to the emulator control card.
LIDEN	LOW IDENTIFICATION ENABLE. Goes low when the mainframe processor scans the ID codes of the cards on the mainframe bus to enable each card to respond with its ID.
LMSYN	LOW MEMORY SYNC. Goes low to force the mainframe processor to wait for the current read or write cycle to be completed by the emulation subsystem. Also an Interschematic mnemonic.
LSEL	LOW SELECT. Input from mainframe (LSS0-9) I/O board. Goes low when the mainframe processor selects this board. Also an interschematic mnemonic.
LSTB	LOW STROBE. Goes low during a mainframe processor read to allow the selected device to drive the data bus. Goes low during a mainframe processor read to indicate bus data is valid. Also an interschematic mnemonic.
LSTM	LOW START MEMORY. Goes low when the mainframe processor initiates a memory cycle and address bus and bus data is valid. Also an Interschematic mnemonic.
LWRT	LOW WRITE. Goes low to indicate a mainframe processor write to the selected device. Also an interschematic mnemonic.

Table 8-1. Mnemonics (Cont'd)

EMULATION SUBSYSTEM INTERFACE

BA0-15	BUFFERED ADDRESS 0-15. Used to access background and emulation memory. Also a Memory and Analysis Interface mnemonic.
BA	BUS AVAILABLE. Input from Emulation microprocessor. Goes high to indicate a processor halt or wait state. Also a Pod Interface, and a Memory and Analysis Interface mnemonic.
CNREGCLK	CONTROL REGISTER CLOCK. Gates mainframe processor data into the control register.
ENILLOP	ENABLE ILLEGAL OPCODE DETECTOR. Enables the illegal opcode detector under control of the control register.
ENJAMCTR	ENABLE JAM COUNTER. Goes high to enable the Jam counter.
E2D0-7	SECOND EMULATION DATA BUS. Nonmultiplexed 8-bit bidirectional data bus used for background memory, illegal opcode detector and synchronizer operations.
FG	BACKGROUND. Goes high to indicate the emulation subsystem is running in the foreground memory.
HANAL	HIGH ANALYSIS. Goes high to store the last referenced memory address into the last address register.
HBGKCS	HIGH BACKGROUND CHIP SELECT. Enables Background Memory RAMs.
HBMR	HIGH BACKGROUND MEMORY REQUEST. Goes high when the mainframe processor requests a Background Memory operation.
HBREAK	HIGH BREAK. Goes high to cause an emulator processor break.
HERD	HIGH EMULATION READ. Buffered R/W signal. Goes high when emulator is in a read cycle.
HEWRT	HIGH EMULATOR WRITE. Inverted R/W signal. Goes high to indicate the emulation processor is performing a write operation.
HFETCH1	HIGH FETCH 1. Goes high during an emulator opcode fetch.
HILLOP	HIGH ILLEGAL OPCODE. Goes high to indicate an illegal opcode was detected.
HMAV	HIGH MEMORY AVAILABLE. Goes high when the emulator is not using memory.

Table 8-1. Mnemonics (Cont'd)

HUSER	HIGH USER. Goes high when the current address on the emulation address bus is mapped to user memory.
INT/EXT	INTERNAL/EXTERNAL CLOCK. Clock select signal sent to the pod by the mainframe processor through the control register. When high the oscillator in the pod is selected, when low the target system clock will be used.
JAM	JAM. Goes high when the Background Controller is outputting the jam addresses onto the address bus.
JAMP	JAM PRIME. Goes high to enable the JAM counter and the address buffer from the JAM counter to the lower 8 bits of BA0-7.
LANAL	LOW ANALYSIS. Goes high to store analysis data nto the internal analysis board.
LAB	LOW AVAILABLE BUS. Inverted BA signal. Goes low when the emulation processor is not using the bus.
LBDEFIB2	LOW BUFFERED DEFIBRILATE 2. Buffered LDEFIB2 signal which is part of the emulation reset function. Goes low when mainframe processor resets the emulator.
LBKG	LOW BACKGROUND. Goes low when the background controller enters the background mode.
LBKGP	LOW BACKGROUND PRIME. Goes low to signal the pod that the system is in the background mode.
LBKGWR	LOW BACKGROUND WRITE. Goes low to indicate a write to background RAM is enabled.
LDEFIB	LOW DEFIBRILLATION. Goes low when the mainframe processor resets the processor in the emulator pod.
LDEFIB2	LOW DEFIBRILLATION 2. Goes low to initialize timing circuits when the mainframe processor resets the emulation subsystem.
LDEFIB3	LOW DEFIBRILLATION 3. Goes low to initialize the memory operation sequence in the background controller when the mainframe processor resets the emulation subsystem.
LDO-7	LOW DATA 0-7. Bidirectional 8-bit data bus. Communications path from the mainframe processor the emulator control card.
LEBREAK	LOW EMULATION BREAK. Goes low when the emulation bus requests a break of the emulation system.

Table 8-1. Mnemonics (Cont'd)

LEWRT	LOW EMULATOR WRITE. Buffered emulator R/W signal. Goes low when the emulator is in a write cycle.
LFG	LOW FOREGROUND. Goes low when the Background Controller is in the foreground mode.
LHOST	LOW HOST. Goes low when the mainframe processor initiates a background cycle.
LHOSTBRK	LOW HOST PROCESSOR BREAK. Goes low when the mainframe processor requests an interrupt of the emulation processor.
LIDEN	LOW IDENTIFICATION ENABLE. Goes low when the Mainframe processor scans the ID codes of the cards on the mainframe bus to enable each card to respond with its ID.
LIMPJAM	LOW IMPENDING JAM. Goes low to indicate that a JAM cycle will occur on the next falling edge of LMEM1.
LIQ	LOW INTERRUPT QUALIFIER. Inverted IQ signal.
LJAM	LOW JAM. Goes low to indicate the emulator is in the JAM mode.
LJAMP	LOW JAM PRIME. Used to select the source for the emulator address signals on the emulation bus. Selects between the Jam Counter and the emulation processor.
LLADDRESS	LOW LAST ADDRESS READ. Goes low when the mainframe processor reads the Last Opcode Address Register.
LMBRKS	LOW MEMORY BREAK STATUS. Goes low when the Emulation Memory Board asserts a break.
LMEM	LOW MEMORY. Used to synchronize the background memory controller to the emulation processor.
LMEM2	LOW MEMORY 2. Goes low to indicate that the address currently on the address bus is valid, used as a clock by the Background Controller.
LMSYN	LOW MEMORY SYNC. Goes low to force the mainframe processor to wait until completion of the current read or write cycle by the emulator.
LLOPREAD	LOW LAST OP CODE READ. Goes low when the mainframe processor reads The Last Opcode Register.

Table 8-1. Mnemonics (Cont'd)

LREFREQ	LOW REFRESH REQUEST. Not used with current memory and analysis boards. When used, would allow the emulation processor in the pod to be stopped for emulation memory refresh cycles. Since no dynamic memory is now used, this line is held high.
LRESET	LOW RESET. Buffered emulation reset line. Goes low whenever a reset is applied to the emulation processor.
LSEL	LOW SELECT. Input from mainframe I/O board LSS0-9. Goes low when the mainframe processor selects this board.
LSTB	LOW STROBE. Goes low during a mainframe processor read to allow the device addressed to drive the data bus. Goes low during a write when the bus data is valid.
LSTM	LOW START MEMORY. Goes low when the mainframe processor initiates a memory cycle to indicate the address bus data is valid.
LSTREAD	LOW STATUS REGISTER READ. Goes low when the mainframe processor reads the contents of the microprocessor pin status and miscellaneous status registers.
LUSER	LOW USER. Goes low to indicate the current address on the emulation address bus is mapped to user memory.
LWBM	LOW WRITE BACKGROUND MEMORY. Goes low to enable writes to background memory.
LWDV	LOW WRITE DATA VALID. Goes low during a memory or I/O write cycle when data on the emulation data bus is valid. Also a Memory and analysis Interface mnemonic.
LWRT	LOW WRITE. Goes low to indicate a mainframe processor write to the addressed device.
MEM	MEMORY. Goes high to indicate the address on the emulation address bus is valid. Used to clock the start Jam Counter flip-flop.
PFG	PREFOREGROUND. Goes high to indicate the background controller is going to change from background to foreground mode.
PMOP	PRE-MEMORY OPERATION. Goes high to indicate a read or write operation on user memory by the emulator will take place on the next falling edge of LMEM2.
RDBKGSTB	READ BACKGROUND STROBE. Goes low to indicate the mainframe processor is performing a read of background memory.

Table 8-1. Mnemonics (Cont'd)

R/W	READ/LOW WRITE. The emulation processor holds this line high for read operations and low for write operations.
WRBKGSTB	WRITE BACKGROUND STROBE. Goes low to indicate a mainframe processor write to background memory.

Table 8-2. Logic Symbols

GENERAL

All signals flow from left to right, relative to the symbol's orientation with inputs on the left side of the symbol, and outputs on the right side of the symbol (the symbol may be reversed if the dependency notation is a single term.)

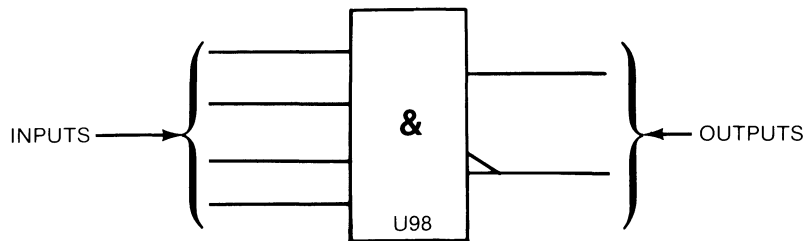
All dependency notation is read from left to right (relative to the symbol's orientation).

An external state is the state of an input or output outside the logic symbol.

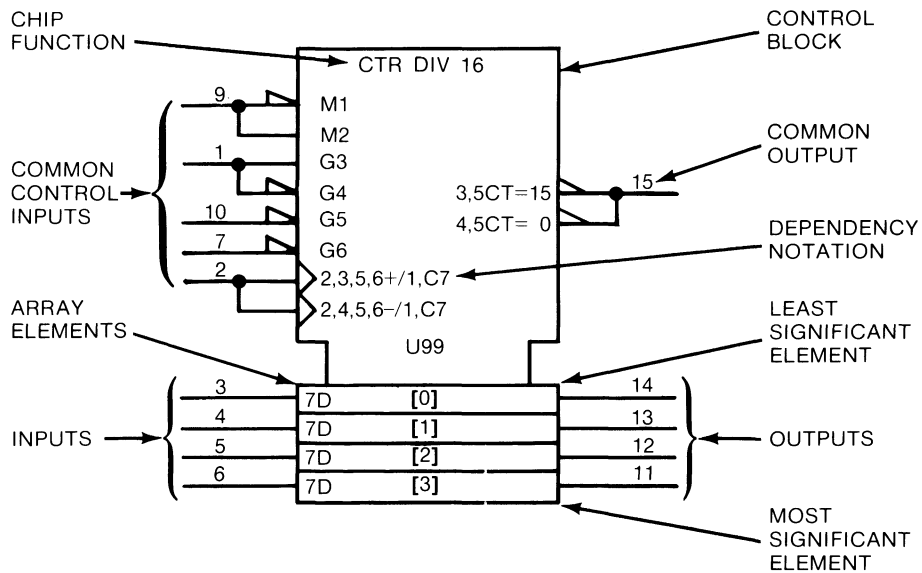
An internal state is the state of an input or output inside the logic symbol. All internal states are True = High.

SYMBOL CONSTRUCTION

Some symbols consist of an outline or combination of outlines together with one or more qualifying symbols, and the representation of input and output lines.



Some have a common Control Block with an array of elements:



CONTROL BLOCK - All inputs and dependency notation affect the array elements directly. Common outputs are located in the control block. (Control blocks may be above or below the array elements.)

ARRAY ELEMENTS -All array elements are controlled by the control block as a function of the dependency notation. Any array element is independent of all other array elements. Unless indicated, the least significant element is always closest to the control block. The array elements are arranged by binary weight. The weights are indicated by powers of 2 (shown in []).

Table 8-2. Logic Symbols (Cont'd)

INPUTS - Inputs are located on the left side of the symbol and are affected by their dependency notation.

Common control inputs are located in the control block and control the inputs/outputs to the array elements according to the dependency notation.

Inputs to the array elements are located with the corresponding array element with the least significant element closest to the control block.

OUTPUTS - Outputs are located on the right side of the symbol and are effected by their dependency notation.

Common control outputs are located in the control block.

Outputs of array elements are located in the corresponding array element with the least significant bit closest to the control block.

CHIP FUNCTION - The labels for chip functions are defined, i.e., CTR - counter, MUX - multiplexer.

DEPENDENCY NOTATION

Dependency notation is always read from left to right relative to the symbol's orientation.

Dependency notation indicates the relationship between inputs, outputs, or inputs and outputs. Signals having a common relationship will have a common number, i.e., C7 and 7D....C7 controls D. Dependency notation 2,3,5,6+/1,C7 is read as when 2 and 3 and 5 and 6 are true, the input will cause the counter to increment by one count....or (/) the input (C7) will control the loading of the input value (7D) into the D flip-flops.

The following types of dependencies are defined:




























- a. AND (G), OR (V), and Negate (N) denote Boolean relationship between inputs and outputs in any combination.
- b. Interconnection (Z) indicates connections inside the symbol.
- c. Control (C) identifies a timing input or a clock input of a sequential element and indicates which inputs are controlled by it.
- d. Set (S) and Reset (R) specify the internal logic states (outputs) of an RS bistable element when the R or S input stands at its internal 1 state.
- e. Enable (EN) identifies an enable input and indicates which inputs and outputs are controlled by it (which outputs can be in their high impedance state).
- f. Mode (M) identifies an input that selects the mode of operation of an element and indicates the inputs and outputs depending on that mode.
- g. Address (A) identifies the address inputs.
- h. Transmission (X) identifies bi-directional inputs and outputs that are connected together when the transmission input is true.

DEPENDENCY NOTATION SYMBOLS

A	Address (selects inputs/outputs) (indicates binary range)	N	Negate (compliments state)
C	Control (permits action)	R	Reset Input
EN	Enable (permits action)	S	Set Input
G	AND (permits action)	V	OR (permits action)
M	Mode (selects action)	Z	Interconnection
		X	Transmission

Table 8-2. Logic Symbols (Cont'd)

OTHER SYMBOLS

 Analog Signal	 Inversion	 Shift Right (or up)
 AND	 Negation	 Solidus (allows an input or output to have more than one function)
 Bit Grouping	 Nonlogic Input/Output	 Tri-State
 Buffer	 Open Circuit (NPN) (external resistor)	 Causes notation and symbols to effect inputs/outputs in an AND relationship, and to occur in the order read from left to right.
 Compare	 Open Circuit (PNP) (external resistor)	 Used for factoring terms using algebraic techniques.
 Dynamic	 OR	 Information not defined.
 Exclusive OR	 Passive Pull Down (internal resistor)	 Logic symbol not defined due to complexity.
 Hysteresis	 Passive Pull Up (internal resistor)	
 Interrogation	 Postponed	
 Internal Connection	 Shift Left (or down)	

LABELS

BG	Borrow Generate	CO	Carry Output	J	J Input
BI	Borrow Input	CP	Carry Propagate	K	K Input
BO	Borrow Output	CT	Content	P	Operand
BP	Borrow Propagate	D	Data Input	T	Transition
CG	Carry Generate	E	Extension (input or output)	+	Count Up
CI	Carry Input	F	Function	-	Count Down

MATH FUNCTIONS

Σ	Adder	>	Greater Than
ALU	Arithmetic Logic Unit	<	Less Than
COMP	Comparator	CPG	Look Ahead Carry Generator
DIV	Divide By	π	Multiplier
=	Equal To	P-Q	Subtractor

CHIP FUNCTIONS

BCD	Binary Coded Decimal	DIR	Directional	RAM	Random Access Memory
BIN	Binary	DMUX	Demultiplexer	RCVR	Line Receiver
BUF	Buffer	FF	Flip-Flop	ROM	Read Only Memory
CTR	Counter	MUX	Multiplexer	SEG	Segment
DEC	Decimal	OCT	Octal	SRG	Shift Register

DELAY and MULTIVIBRATORS






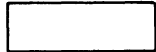
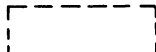






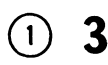


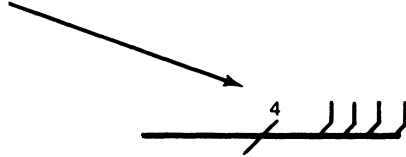
 Astable	
 Delay	
 Nonretriggerable Monostable	
NV	Nonvolatile
 Retriggerable Monostable	

Table 8-3. Schematic Diagram Notes

	ETCHED CIRCUIT BOARD	(925)	WIRE COLORS ARE GIVEN BY NUMBERS IN PARENTHESES USING THE RESISTOR COLOR CODE
	FRONT PANEL MARKING		[(925) IS WHT-RED-GRN]
	REAR-PANEL MARKING		0 - BLACK 5 - GREEN 1 - BROWN 6 - BLUE 2 - RED 7 - VIOLET 3 - ORANGE 8 - GRAY 4 - YELLOW 9 - WHITE
	MANUAL CONTROL		* OPTIMUM VALUE SELECTED AT FACTORY, TYPICAL VALUE SHOWN; PART MAY HAVE BEEN OMITTED.
	SCREWDRIVER ADJUSTMENT		
	ELECTRICAL TEST POINT TP (WITH NUMBER)		UNLESS OTHERWISE INDICATED: RESISTANCE IN OHMS CAPACITANCE IN PICO FARADS INDUCTANCE IN MICROHENRIES
	NUMBERED WAVEFORM NUMBER CORRESPONDS TO ELECTRICAL TEST POINT NO.	μP =	MICROPROCESSOR
	LETTERED TEST POINT NO MEASUREMENT AID PROVIDED	P/O =	PART OF
	COMMON CONNECTIONS. ALL LIKE-DESIGNATED POINTS ARE CONNECTED.	NC =	NO CONNECTION
	NUMBER ON WHITE BACKGROUND = OFF-PAGE CONNECTION. LARGE NUMBER ADJACENT = SERVICE SHEET NUMBER FOR OFF-PAGE CONNECTION.	CW =	CLOCKWISE END OF VARIABLE RESISTOR
	CIRCLED LETTER = OFF-PAGE CONNECTION BETWEEN PAGES OF SAME SERVICE SHEET.		
	INDICATES SINGLE SIGNAL LINE		
	NUMBER OF LINES ON A BUS		
			

STD-20-09-81

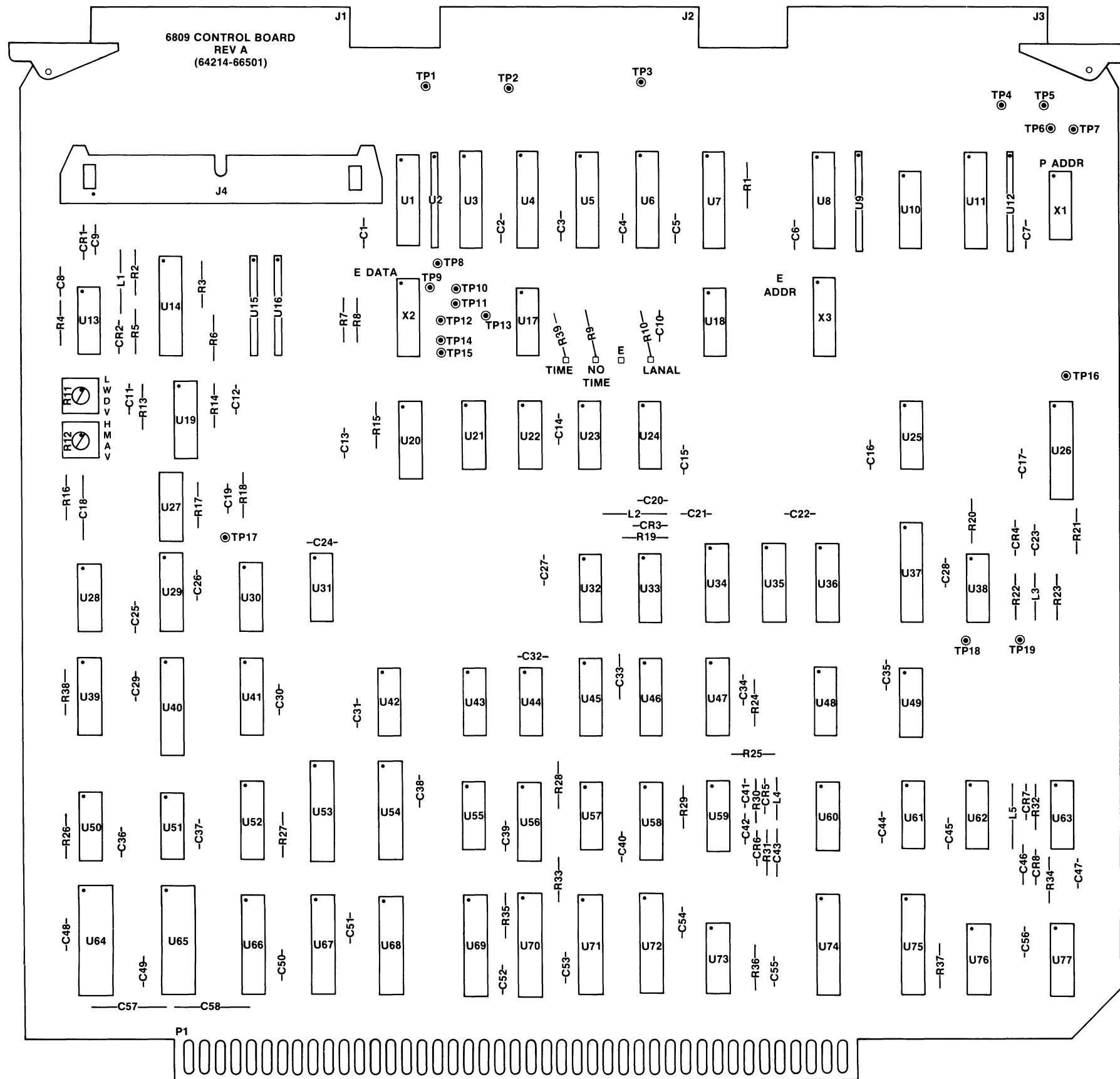
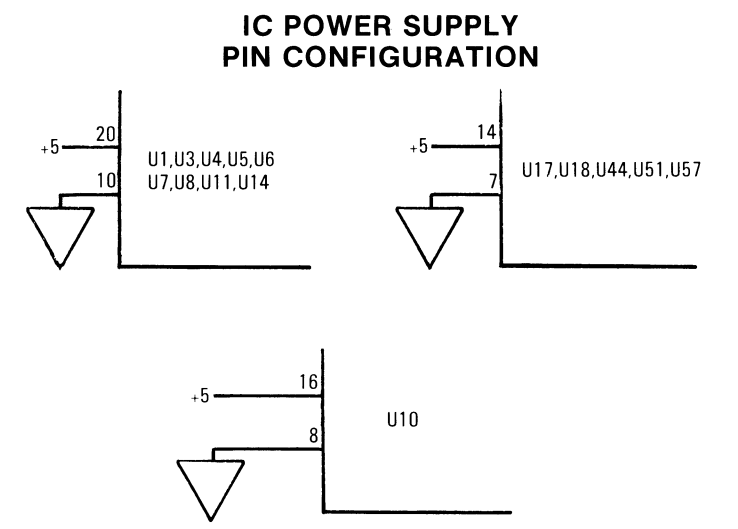
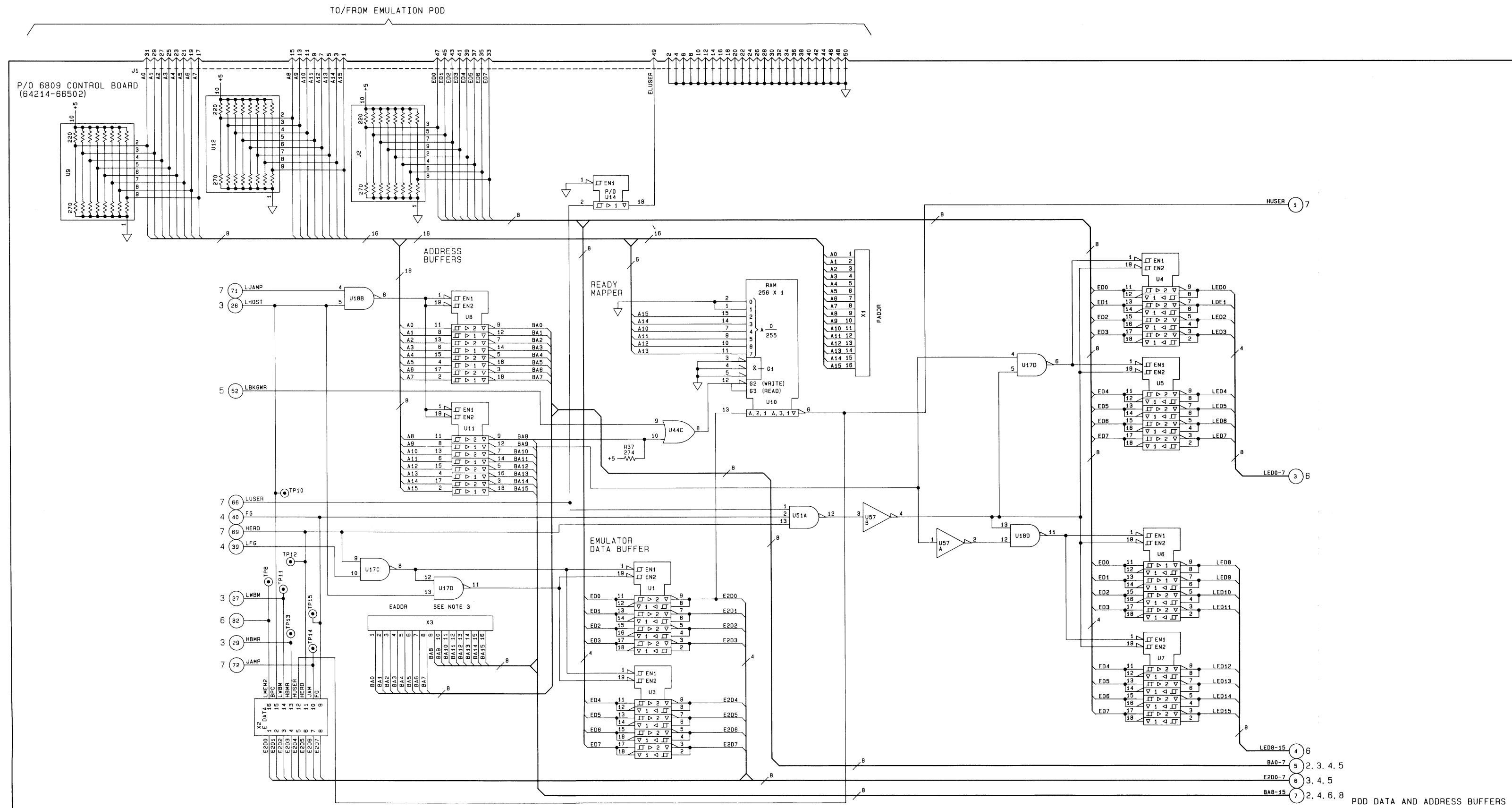


Figure 8-1. 6809 Emulator Control Board, Component Locator



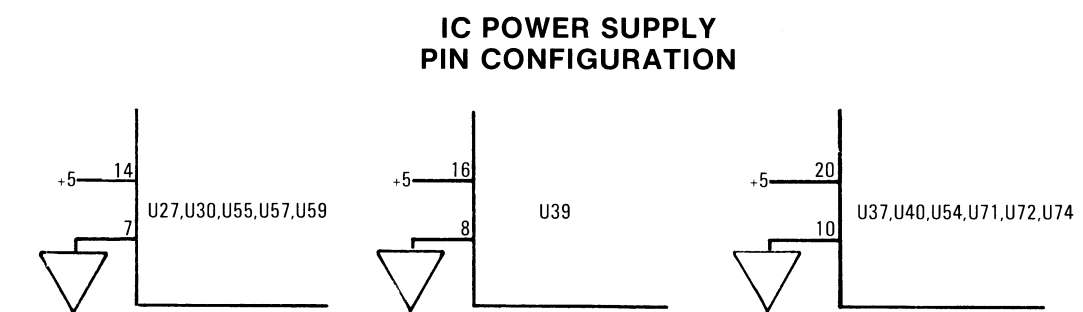
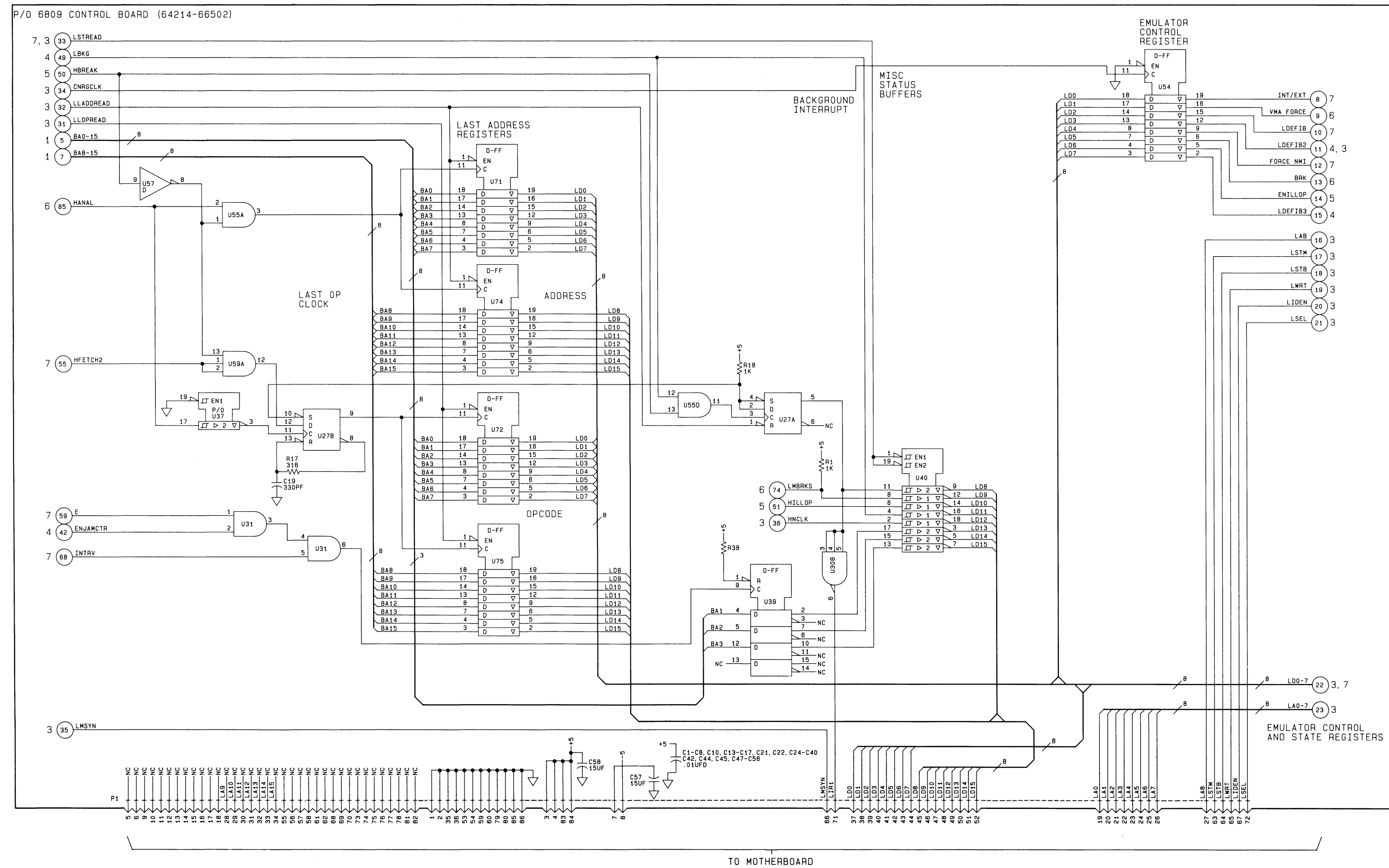
ICS ON THIS SCHEMATIC

Ref Des	HP Part No	Mfr Part No
U1, U3, U8, U11	1820-1633	74S240
U10	1816-1092	27LS00
U14	1820-1624	74S241
U17, U18	1820-0681	74S00
U44	1820-1449	74S32
U51	1820-0685	75S10
U57	1820-0683	74S04

PARTS ON THIS SCHEMATIC

J1
R37
TP8-TP15
U1-U12, U14, U17, U18, U44, U51, U57
X1-X3

Figure 8-2. Service Sheet 1, Data and Address Buffers
8-15/(8-16 blank)
Change 1



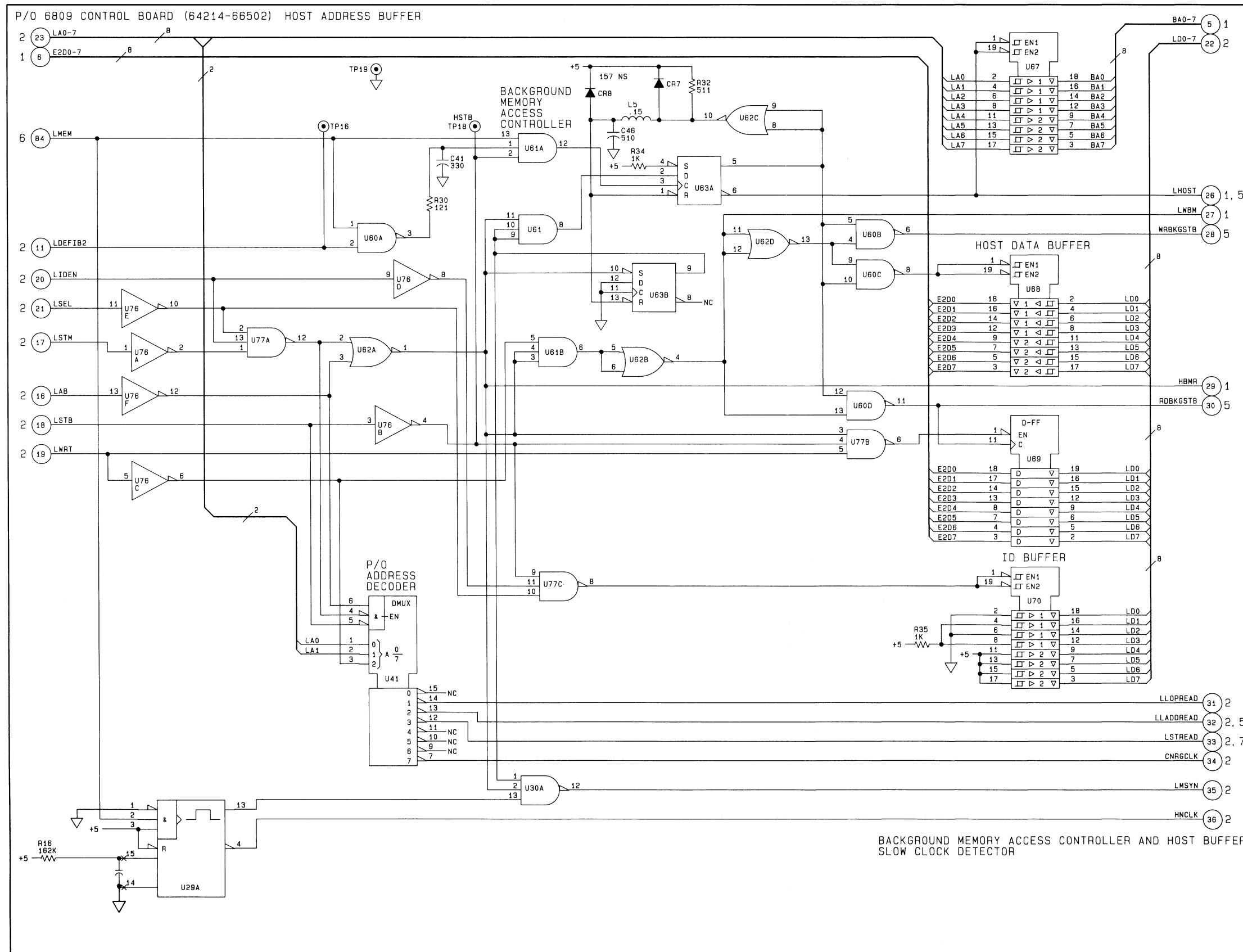
ICS ON THIS SCHEMATIC

Ref Des	HP Part No	Mfr Part No
U27	1820-1112	74LS74
U30	1820-0907	7412
U37	1820-1633	745240
U39	1820-1195	74LS175
U40	1820-2024	74LS244
U54,U71,U72, U74,U75	1820-1997	74LS374
U55	1820-1367	74S08
U57	1820-0683	74S04
U59	1820-0686	74S11

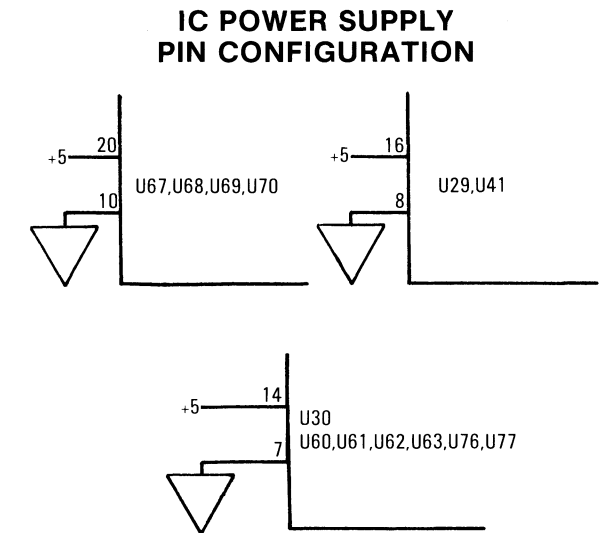
PARTS ON THIS SCHEMATIC

C1-C8,C10,C13-C17,C19,C21,C22,C24-C40,C42,
C44,C45,C47-C56,C57,C58
P1
R1,R17,R18,R38
U27,U30,U37,U39,U40,U54,U57,U59,U71,U72,U74,U75

Figure 8-3. Service Sheet 2, Mainframe Interface Logic 8-17/(8-18 blank) Change 1



3



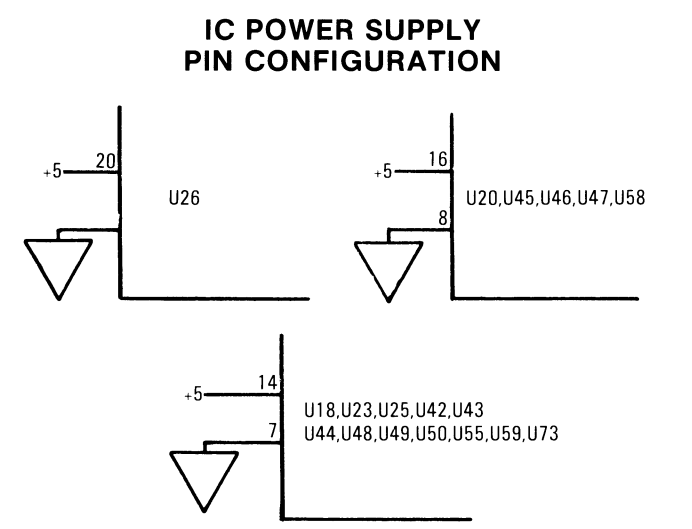
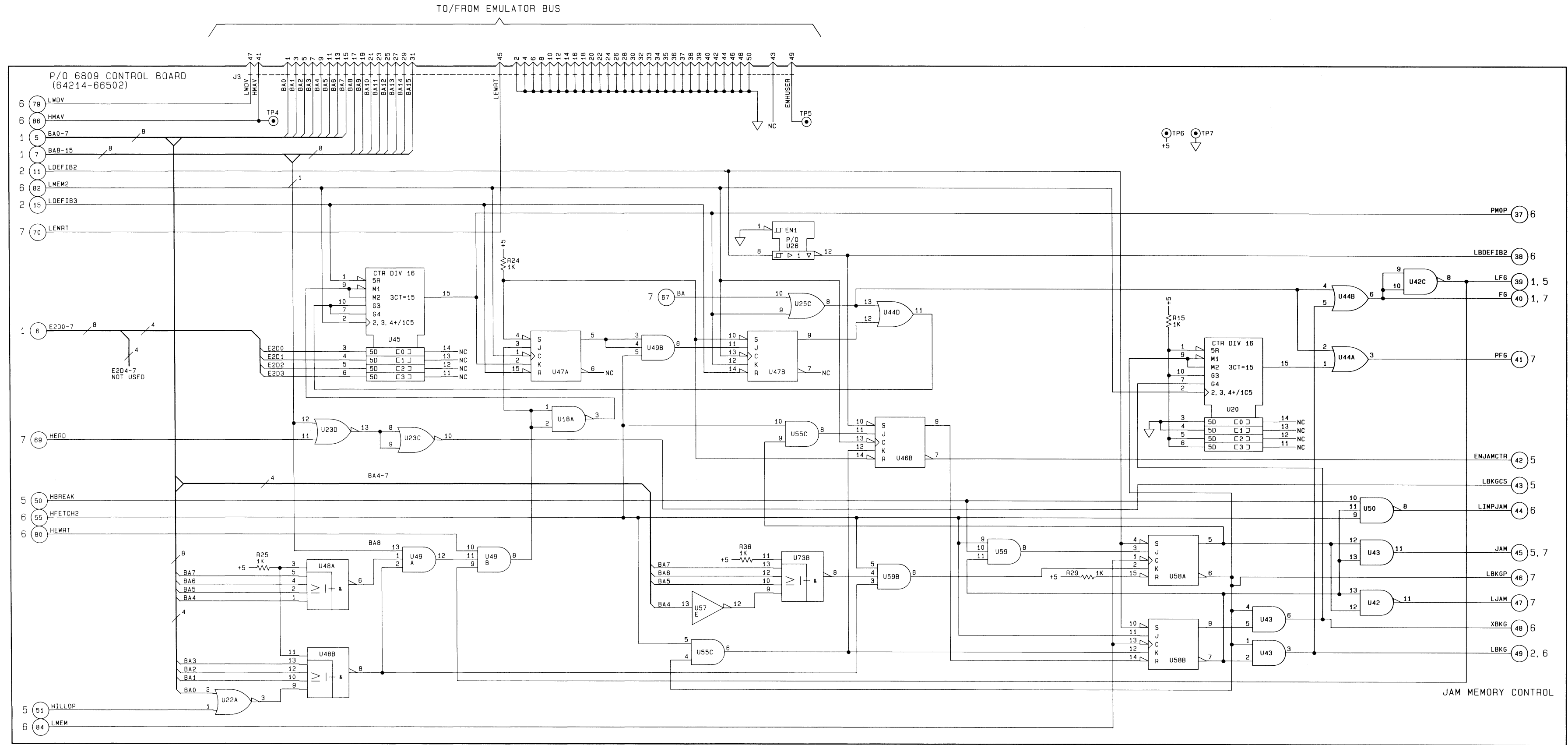
ICS ON THIS SCHEMATIC

Ref Des	HP Part No	Mfr Part No
U29	1820-1423	74LS123
U30	1820-0907	7412
U41	1820-1216	74LS138
U60	1820-0681	74S00
U61	1820-0686	74S11
U62	1820-1322	74S02
U63	1820-0693	74S74
U67,U68,U70	1820-2024	74LS244
U69	1820-1997	74LS374
U76	1820-1416	74LS14
U77	1820-1202	74LS10

PARTS ON THIS SCHEMATIC

- C18, C41, C46
- CR7, CR8
- L5
- R16, R30, R32, R34, R35
- TP16, TP18, TP19
- U29, U30, U41, U60-U63, U67-U70, U76, U77

Figure 8-4. Service Sheet 3, Background Memory Controller
8-19/(8-20 blank)
Change 1



ICS ON THIS SCHEMATIC

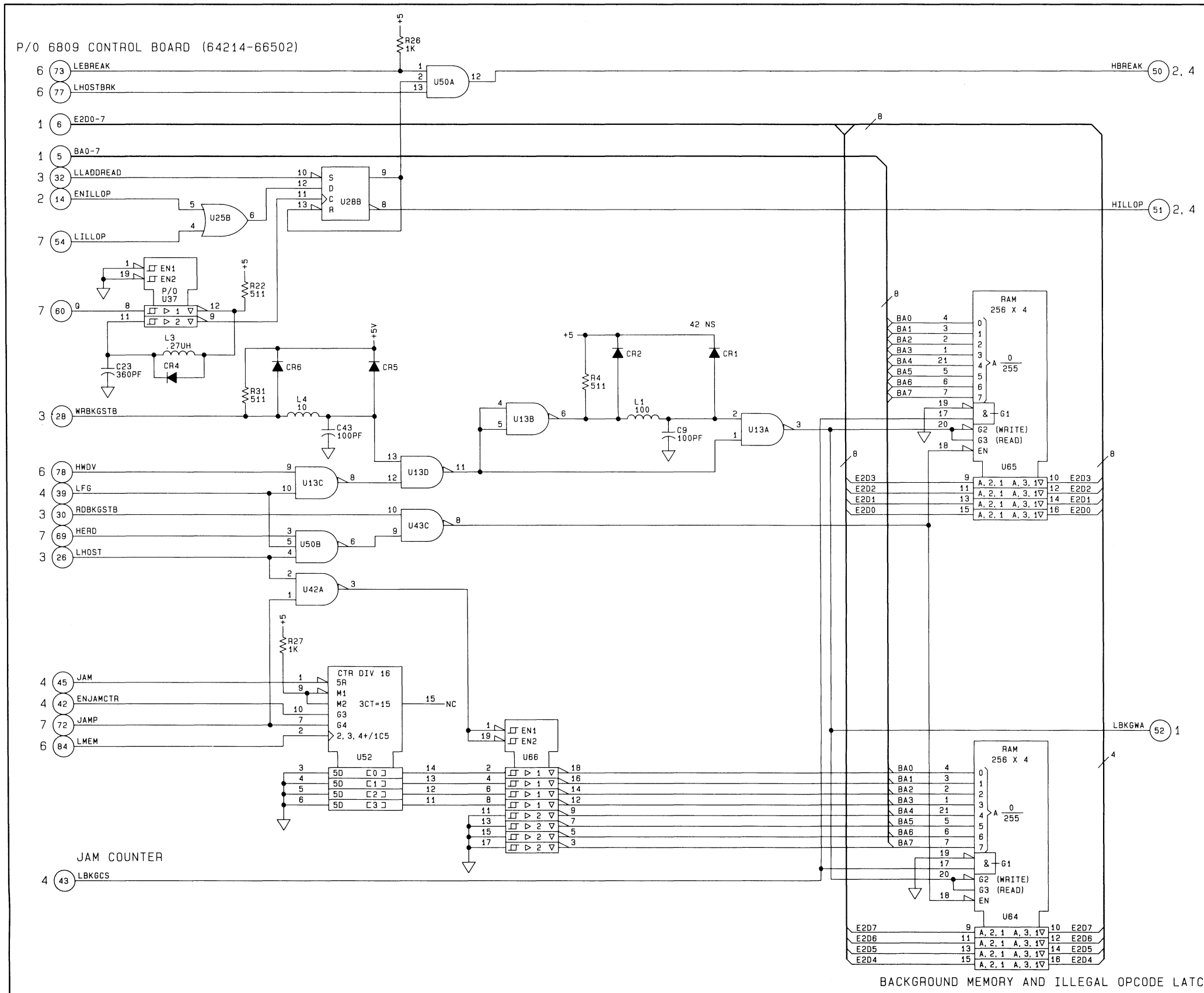
Ref Des	HP Part No	Mfr Part No
U18,U42	1820-0681	74S00
U20,U45	1820-1430	74LS161
U23	1820-1322	74S02
U25,U44	1820-1449	74S32
U26	1820-1624	74S241
U43,U55	1820-1367	74S08
U46,U47,U58	1820-0629	74S112
U48,U73	1820-0655	7425
U49,U59	1820-0686	74S11
U50	1820-0685	74S10

PARTS ON THIS SCHEMATIC

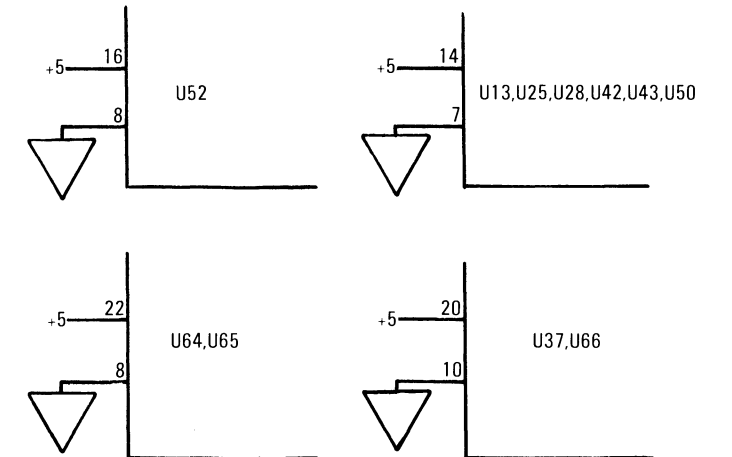
J3
R15,R24,R25,R29,R36
TP4-TP7
U18,U20,U22,U23,U25,U26,U42-U50, U55,U57-U59,U73

4

Figure 8-5. Service Sheet 4, Jam and Foreground Memory Control
8-21/(8-22 blank)
Change 1



IC POWER SUPPLY PIN CONFIGURATION



ICS ON THIS SCHEMATIC

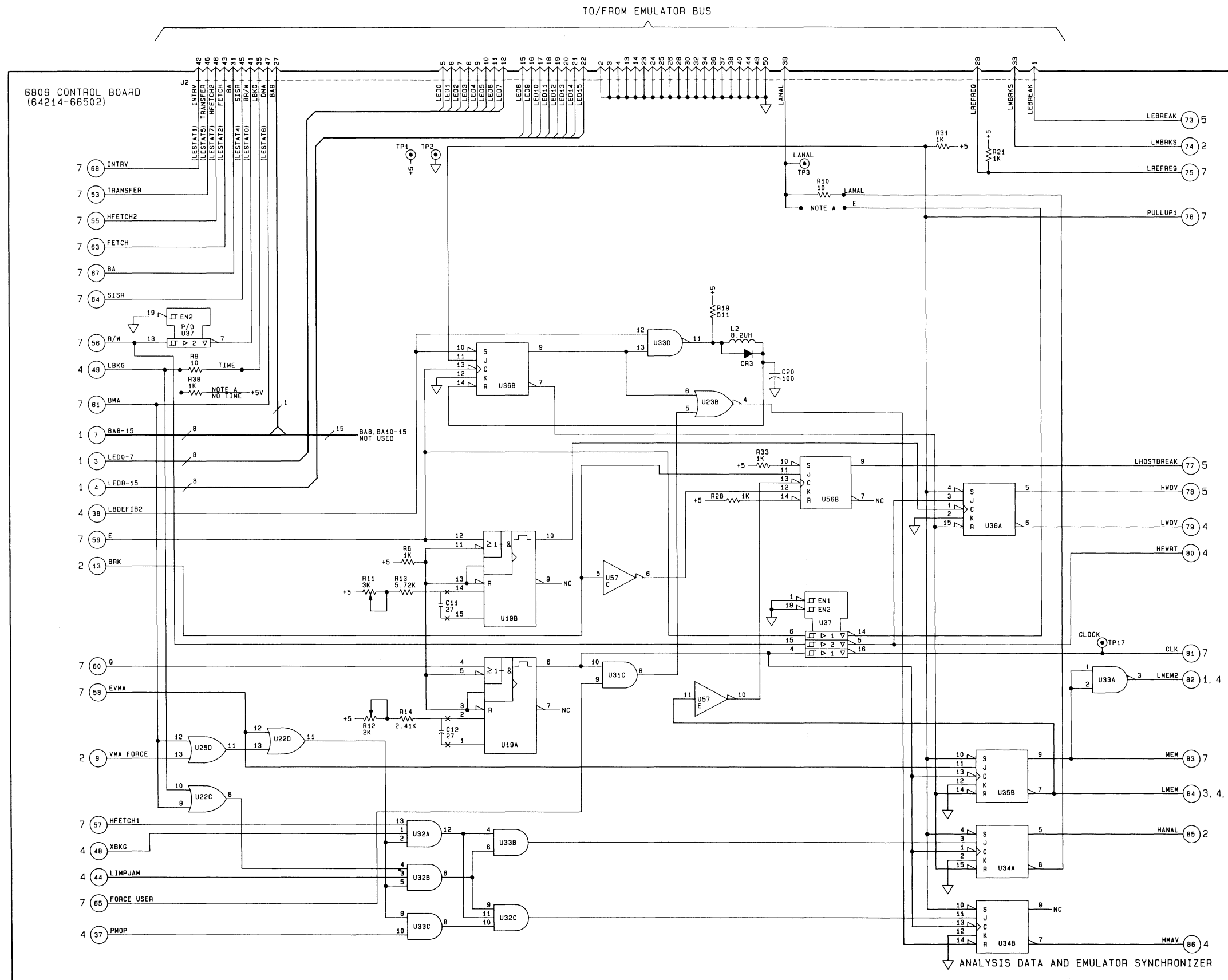
Ref Des	HP Part No	Mfr Part No
U13, U42	1820-0681	74S00
U25	1820-1449	74S32
U28	1820-0693	74S74
U37	1820-1633	74S240
U43	1820-1367	74S08
U50	1820-0685	74S10
U52	1820-1432	74LS163
U64, U65	1816-1334	9S422
U66	1820-1917	74LS240

PARTS ON THIS SCHEMATIC

C9, C23, C43
CR1, CR2, CR4, CR5, CR6
L1, L3, L4
R4, R22, R26, R27, R31
U13, U25, U28, U37, U42, U43, U50, U52, U64-U66

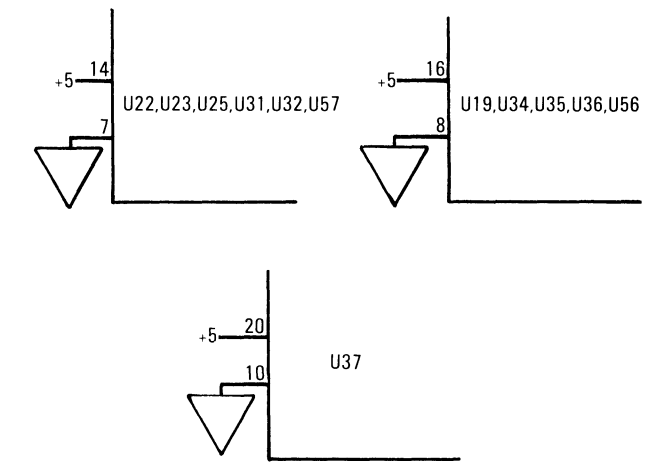
5

Figure 8-6. Service Sheet 5, Background Memory 8-23/(8-24 blank) Change 1



6

IC POWER SUPPLY PIN CONFIGURATION



ICS ON THIS SCHEMATIC

Ref Des	HP Part No	Mfr Part No
U19	1820-1782	26S02
U22,U25	1820-1449	74S32
U23	1820-1322	74S02
U31	1820-1367	74S08
U32	1820-0685	74S10
U33	1820-0681	74S00
U34-U36,U56	1820-0629	74S112
U37	1820-1633	74S240
U57	1820-0683	74S04

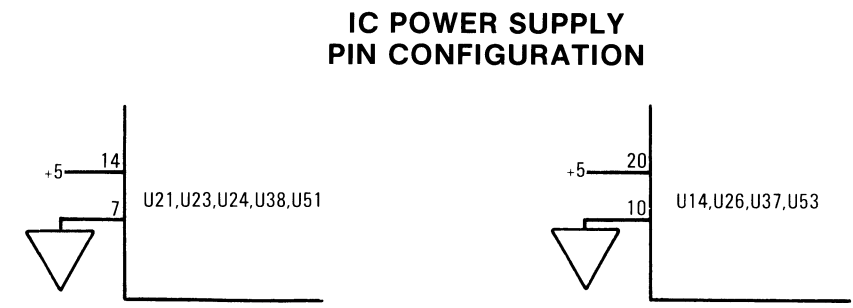
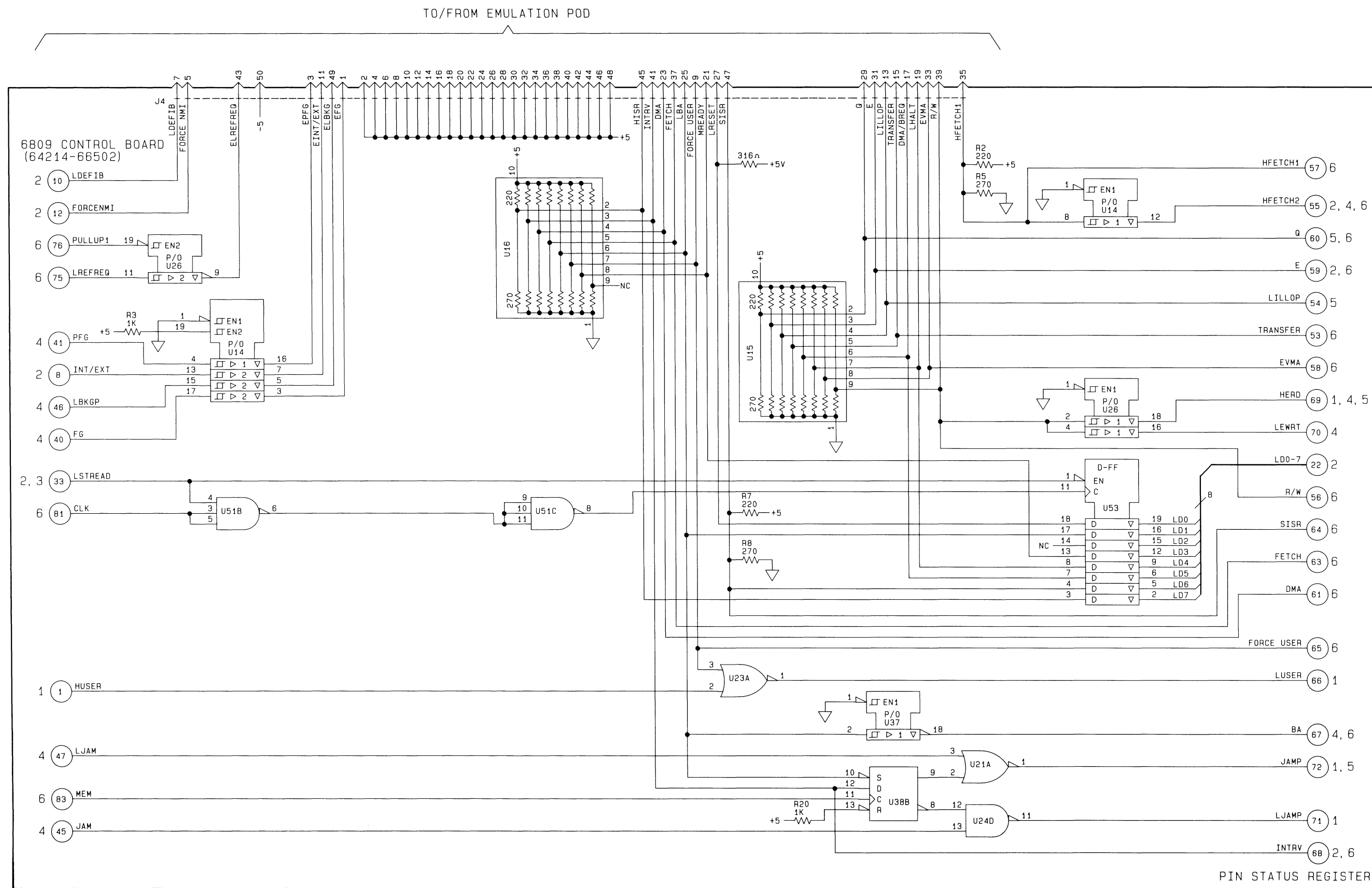
PARTS ON THIS SCHEMATIC

- C11,C12,C20
- CR3
- L2
- J2
- R6,R9-R14,R19,R21,R23,R28,R33,R39
- TP1,TP2,TP3,TP17
- U19,U22,U23,U25,U31-U37,U56,U57

NOTE A

For normal operation the Model 64214A should be configured as illustrated on this schematic. The alternate configuration is for factory diagnostics only.

Figure 8-7. Service Sheet 6, Mainframe/Emulator Synchronizer 8-25/(8-26 blank) Change 1



ICS ON THIS SCHEMATIC

Ref Des	HP Part No	Mfr Part No
U14,U26	1820-1624	74S241
U21,U23	1820-1322	74S02
U24	1820-0681	74S00
U37	1820-1633	74S240
U38	1820-0693	74S74
U51	1820-0685	74S10
U53	1820-1997	74LS374

PARTS ON THIS SCHEMATIC

J4
R2,R3,R5,R7,R8,R20
U14-U16,U21,U23,U24,U26,U27,U38,U51,U53

7

Figure 8-8. Service Sheet 7, Analysis Data and Pin Status 8-27 Change 1



SALES & SUPPORT OFFICES

Arranged alphabetically by country

PERU

Cía Electro Médica S.A.
Los Flamencos 145, San Isidro
Casilla 1030
LIMA 1
Tel: 41-4325, 41-3703
Telex: Pub. Booth 25306
CM,E,M,P

PHILIPPINES

The Online Advanced Systems Corporation
Rico House, Amoroso Cor. Herrera Street
Legaspi Village, Makati
P.O. Box 1510
Metro MANILA
Tel: 85-35-81, 85-34-91, 85-32-21
Telex: 3274 ONLINE
A,CH,CS,E,M

Electronic Specialists and Proponents Inc.
690-B Epifanio de los Santos Avenue
Cubao, **QUEZON CITY**
P.O. Box 2649 Manila
Tel: 98-96-81, 98-96-82, 98-96-83
Telex: 40018, 42000 ITT GLOBE
MACKAY BOOTH
P

PORTUGAL

Mundinter
Intercambio Mundial de Comércio S.A.R.L.
P.O. Box 2761
Avenida Antonio Augusto de Aguiar 138
P-LISBOA
Tel: (19) 53-21-31, 53-21-37
Telex: 16691 munter p
M
Soquimica
Av. da Liberdade, 220-2
1298 LISBOA Codex
Tel: 56 21 81/2/3
Telex: 13316 SABASA
P
Telectra-Empresa Técnica de Equipamentos Eléctricos S.A.R.L.
Rua Rodrigo da Fonseca 103
P.O. Box 2531
P-LISBOA 1
Tel: (19) 68-60-72
Telex: 12598
CH,CS,E,P

PUERTO RICO

Hewlett-Packard Puerto Rico
P.O. Box 4407
CAROLINA, Puerto Rico 00628
Calle 272 Edificio 203
Urb. Country Club
RIO PIEDRAS, Puerto Rico
Tel: (809) 762-7255
A,CH,CS

QATAR

Computearbia
P.O. Box 2750
DOHA
Tel: 883555
Telex: 4806 CHPARB
P
Eastern Technical Services
P.O. Box 4747
DOHA
Tel: 329 993
Telex: 4156 EASTEC DH

Nasser Trading & Contracting
P.O. Box 1563
DOHA
Tel: 22170, 23539
Telex: 4439 NASSER DH
M

SAUDI ARABIA

Modern Electronic Establishment
Hewlett-Packard Division
P.O. Box 281
Thuobah
AL-KHOBAR
Tel: 864-46 78
Telex: 671 106 HPMEEK SJ
Cable: ELECTA AL-KHOBAR
CH,CS,E,M,P

Modern Electronic Establishment
Hewlett-Packard Division
P.O. Box 1228
Redec Plaza, 6th Floor
JEDDAH
Tel: 644 38 48
Telex: 4027 12 FARNAS SJ
Cable: ELECTA JEDDAH
CH,CS,E,M,P

Modern Electronic Establishment
Hewlett-Packard Division
P.O. Box 2728
RIYADH
Tel: 491-97 15, 491-63 87
Telex: 202049 MEERYD SJ
CH,CS,E,M,P

SCOTLAND

See United Kingdom

SINGAPORE

Hewlett-Packard Singapore (Sales)
Pte. Ltd.
P.O. Box 58 Alexandra Post Office
SINGAPORE, 9115
6th Floor, Inchcape House
450-452 Alexandra Road
SINGAPORE 0511
Tel: 631788
Telex: HPSGSO RS 34209
Cable: HEWPACK, Singapore
A,CH,CS,E,MS,P
Dynamar International Ltd.
Unit 05-11 Block 6
Kolam Ayer Industrial Estate
SINGAPORE 1334
Tel: 747-6188
Telex: RS 26283
CM

SOUTH AFRICA

Hewlett-Packard So Africa (Pty.)
Ltd.
P.O. Box 120
Howard Place **CAPE PROVINCE** 7450
Pine Park Center, Forest Drive,
Pinelands
CAPE PROVINCE 7405
Tel: 53-7954
Telex: 57-20006
A,CH,CM,E,MS,P
Hewlett-Packard So Africa (Pty.)
Ltd.
P.O. Box 37099
92 Overport Drive
DURBAN 4067
Tel: 28-4178, 28-4179, 28-4110
Telex: 6-22954
CH,CM

Hewlett-Packard So Africa (Pty.)
Ltd.
6 Linton Arcade
511 Cape Road
Linton Grange
PORT ELIZABETH 6001
Tel: 041-302148
CH

Hewlett-Packard So Africa (Pty.)
Ltd. P.O. Box 33345
Glenstantia 0010 **TRANSVAAL**
1st Floor East
Constantia Park Ridge Shopping
Centre
Constantia Park
PRETORIA
Tel: 982043
Telex: 32163
CH,E

Hewlett-Packard So Africa (Pty.)
Ltd.
Private Bag Wendywood
SANDTON 2144
Tel: 802-5111, 802-5125
Telex: 4-20877
Cable: HEWPACK Johannesburg
A,CH,CM,CS,E,MS,P

SPAIN

Hewlett-Packard Española S.A.
Calle Entenza, 321
E-BARCELONA 29
Tel: 322.24.51, 321.73.54
Telex: 52603 hpbee
A,CH,CS,E,MS,P

Hewlett-Packard Española S.A.
Calle San Vicente S/No
Edificio Albia II
E-BILBAO 1
Tel: 423.83.06
A,CH,E,MS
Hewlett-Packard Española S.A.
Ctra. de la Coruña, Km. 16, 400
Las Rozas
E-MADRID
Tel: (1) 637.00.11
CH,CS,M

Hewlett-Packard Española S.A.
Avda. S. Francisco Javier, S/no
Planta 10. Edificio Sevilla 2,
E-SEVILLA 5
Tel: 64.44.54
Telex: 72933
A,CS,MS,P

Hewlett-Packard Española S.A.
Calle Ramon Gordillo, 1 (Entlo.3)
E-VALENCIA 10
Tel: 361-1354
CH,P

SWEDEN

Hewlett-Packard Sverige AB
Sunnanvagen 14K
S-22226 **LUND**
Tel: (046) 13-69-79
Telex: (854) 17886 (via Spånga
office)
CH
Hewlett-Packard Sverige AB
Vastra Vintergatan 9
S-70344 **OREBRO**
Tel: (19) 10-48-80
Telex: (854) 17886 (via Spånga
office)
CH

Hewlett-Packard Sverige AB
Skalholtsgatan 9, Kista
Box 19
S-16393 **SPÅNGA**
Tel: (08) 750-2000
Telex: (854) 17886
A,CH,CM,CS,E,MS,P
Hewlett-Packard Sverige AB
Frötalligatan 30
S-42132 **VÄSTRA-FRÖLUNDA**
Tel: (031) 49-09-50
Telex: (854) 17886 (via Spånga
office)
CH,E,P

SWITZERLAND

Hewlett-Packard (Schweiz) AG
Clarastrasse 12
CH-4058 BASLE
Tel: (61) 33-59-20
A
Hewlett-Packard (Schweiz) AG
7, rue du Bois-du-Lan
Case Postale 365
CH-1217 MEYRIN 1
Tel: (0041) 22-83-11-11
Telex: 27333 HPAG CH
CH,CM,CS

Hewlett-Packard (Schweiz) AG
Allmend 2
CH-8967 WIDEN
Tel: (0041) 57 31 21 11
Telex: 53933 hpag ch
Cable: HPAG CH
A,CH,CM,CS,E,MS,P

SYRIA

General Electronic Inc.
Nuri Basha P.O. Box 5781
DAMASCUS
Tel: 33-24-87
Telex: 11216 ITIKAL SY
Cable: ELECTROBOR DAMASCUS
E
Middle East Electronics
Place Azmé
P.O. Box 2308
DAMASCUS
Tel: 334592
Telex: 11304 SATACO SY
M,P

TAIWAN

Hewlett-Packard Far East Ltd.
Kaohsiung Office
2/F 68-2, Chung Cheng 3rd Road
KAOHSIUNG
Tel: 241-2318, 261-3253
CH,CS,E

Hewlett-Packard Far East Ltd.
Taiwan Branch
5th Floor
205 Tun Hwa North Road
TAIPEI
Tel: (02) 712-0404
Cable: HEWPACK Taipei
A,CH,CM,CS,E,M,P
Ing Lih Trading Co.
3rd Floor, 7 Jen-Ai Road, Sec. 2
TAIPEI 100
Tel: (02) 3948 191
Cable: INGLIH TAIPEI
A

THAILAND

Unimesa
30 Patpong Ave., Suriwong
BANGKOK 5
Tel: 235-5727
Telex: 84439 Simonco TH
Cable: UNIMESA Bangkok
A,CH,CS,E,M
Bangkok Business Equipment Ltd.
5/5-6 Dejo Road
BANGKOK
Tel: (854) 234-8671
Telex: 87669-BEQUIPT TH
Cable: BUSIQUIPT Bangkok
P

TRINIDAD & TOBAGO

Caribbean Telecoms Ltd.
50/A Jerningham Avenue
P.O. Box 732
PORT-OF-SPAIN
Tel: 62-44213, 62-44214
Telex: 235,272 HUGCO WG
CM,E,M,P

TUNISIA

Tunisie Electronique
31 Avenue de la Liberté
TUNIS
Tel: 280-144
E,P
Corema
1 ter. Av. de Carthage
TUNIS
Tel: 253-821
Telex: 12319 CABAM TN
M

TURKEY

Teknim Company Ltd.
Iran Caddesi No. 7
Kavaklidere, **ANKARA**
Tel: 275800
Telex: 42155 TKNM TR
E
E.M.A.
Medina Eldem Sokak No.41/6
Yuksele Caddesi
ANKARA
Tel: 175 622
M

UNITED ARAB EMIRATES

Emitac Ltd.
P.O. Box 1641
SHARJAH
Tel: 354 121, 354 123
Telex: 68136 Emitac Sh
CH,CS,E,M,P

UNITED KINGDOM

GREAT BRITAIN
Hewlett-Packard Ltd.
Trafalgar House
Navigation Road
ALTRINCHAM
Cheshire WA14 1NU
Tel: (061) 928-6422
Telex: 668068
A,CH,CS,E,M
Hewlett-Packard Ltd.
Oakfield House, Oakfield Grove
Clifton
BRISTOL BS8 2BN, Avon
Tel: (027) 38606
Telex: 444302
CH,M,P

SALES & SUPPORT OFFICES

Arranged alphabetically by country

5



GREAT BRITAIN (Cont'd)

Hewlett-Packard Ltd.
Fourier House
257-263 High Street
LONDON COLNEY
Herts., AL2 1HA, St. Albans
Tel: (0727) 24400
Telex: 1-8952716
CH,CS,E

Hewlett-Packard Ltd.
Quadrangle
106-118 Station Road
REDHILL, Surrey
Tel: (0737) 68655
Telex: 947234
CH,CS,E

Hewlett-Packard Ltd.
Avon House
435 Stratford Road
SHIRLEY, Solihull
West Midlands B90 4BL
Tel: (021) 745 8800
Telex: 339105
CH

Hewlett-Packard Ltd.
West End House 41
High Street, West End
SOUTHAMPTON
Hampshire SO3 3DD
Tel: (703) 886767
Telex: 477138
CH

Hewlett-Packard Ltd.
King Street Lane
WINNERSH, Wokingham
Berkshire RG11 5AR
Tel: (0734) 784774
Telex: 847178
A,CH,E,M

Hewlett-Packard Ltd.
Nine Mile Ride
WOKINGHAM
Berkshire, RG11 3LL
Tel: 3446 3100
Telex: 84-88-05
CH,CS,E

NORTHERN IRELAND

Cardiac Services Company
95A Finaghy Road South
BELFAST BT 10 0BY
Tel: (0232) 625-566
Telex: 747626
M

SCOTLAND

Hewlett-Packard Ltd.
SOUTH QUEENSFERRY
West Lothian, EH30 9GT
Tel: (031) 3311188
Telex: 72682
A,CH,CM,CS,E,M

UNITED STATES

Alabama

Hewlett-Packard Co.
P.O. Box 7000
8290 Whitesburg Drive, S.E.
HUNTSVILLE, AL 35802
Tel: (205) 830-2000
CH,CM,CS,E,M*

Arizona

Hewlett-Packard Co.
8080 Point Parkway West
PHOENIX, AZ 85044
Tel: (602) 273-8000
A,CH,CM,CS,E,MS
Hewlett-Packard Co.
2424 East Aragon Road
TUCSON, AZ 85706
Tel: (602) 889-4631
CH,E,MS**

California

Hewlett-Packard Co.
99 South Hill Dr.
4BRISBANE, CA 94005
Tel: (415) 330-2500
CH,CS
Hewlett-Packard Co.
7621 Canoga Avenue
CANOGA PARK, CA 91304
Tel: (213) 702-8363
A,CH,CS,E,P
Hewlett-Packard Co.
P.O. Box 7830 (93747)
5060 E. Clinton Avenue, Suite 102
FRESNO, CA 93727
Tel: (209) 252-9652
CH,CS,MS

Hewlett-Packard Co.
P.O. Box 4230
1430 East Orangethorpe
FULLERTON, CA 92631
Tel: (714) 870-1000
CH,CM,CS,E,MP
Hewlett-Packard Co.
320 S. Kellogg, Suite B
GOLETA, CA 93117
Tel: (805) 967-3405
CH

Hewlett-Packard Co.
5400 W. Rosecrans Boulevard
LAWNDALE, CA 90260
P.O. Box 92105
LOS ANGELES, CA 90009
Tel: (213) 970-7500
Telex: 910-325-6608
CH,CM,CS,MP
Hewlett-Packard Co.
3200 Hillview Avenue
PALO ALTO, CA 94304
Tel: (415) 857-8000
CH,CS,E
Hewlett-Packard Co.
P.O. Box 15976 (95813)
4244 So. Market Court, Suite A
SACRAMENTO, CA 95834
Tel: (916) 929-7222
A*,CH,CS,E,MS

Hewlett-Packard Co.
9606 Aero Drive
P.O. Box 23333 **SAN DIEGO, CA 92123**
Tel: (619) 279-3200
CH,CM,CS,E,MP
Hewlett-Packard Co.
2305 Camino Ramon "C"
SAN RAMON, CA 94583
Tel: (415) 838-5900
CH,CS

Hewlett-Packard Co.
P.O. Box 4230
Fullerton, CA 92631
363 Brookhollow Drive
SANTA ANA, CA 92705
Tel: (714) 641-0977
A,CH,CM,CS,MP
Hewlett-Packard Co.
3003 Scott Boulevard
SANTA CLARA, CA 95050
Tel: (408) 988-7000
Telex: 910-338-0586
A,CH,CM,CS,E,MP

Hewlett-Packard Co.
5703 Corsa Avenue
WESTLAKE VILLAGE, CA 91362
Tel: (213) 706-6800
E*,CH*,CS*

Colorado

Hewlett-Packard Co.
24 Inverness Place, East
ENGLEWOOD, CO 80112
Tel: (303) 771-3455
Telex: 910-935-0785
A,CH,CM,CS,E,MS

Connecticut

Hewlett-Packard Co.
47 Barnes Industrial Road South
P.O. Box 5007
WALLINGFORD, CT 06492
Tel: (203) 265-7801
A,CH,CM,CS,E,MS

Florida

Hewlett-Packard Co.
P.O. Box 24210 (33307)
2901 N.W. 62nd Street
FORT LAUDERDALE, FL 33309
Tel: (305) 973-2600
CH,CS,E,MP
Hewlett-Packard Co.
P.O. Box 13910
6177 Lake Ellenor Drive
ORLANDO, FL 32809
Tel: (305) 859-2900
A,CH,CM,CS,E,MS

Hewlett-Packard Co.
5750B N. Hoover Blvd., Suite 123
TAMPA, FL 33614
Tel: (813) 884-3282
A*,CH,CM,CS,E*,M*

Georgia

Hewlett-Packard Co.
P.O. Box 105005
30348 ATLANTA,GA
2000 South Park Place
ATLANTA, GA 30339
Tel: (404) 955-1500
Telex: 810-766-4890
A,CH,CM,CS,E,MP

Hawaii

Hewlett-Packard Co.
Kawaiahaio Plaza, Suite 190
567 South King Street
HONOLULU, HI 96813
Tel: (808) 526-1555
A,CH,E,MS

Illinois

Hewlett-Packard Co.
P.O. Box 1607
304 Eldorado Road
BLOOMINGTON, IL 61701
Tel: (309) 662-9411
CH,MS**
Hewlett-Packard Co.
1100 31st Street, Suite 100
DOWNERS GROVE, IL 60515
Tel: (312) 960-5760
CH,CS

Hewlett-Packard Co.
5201 Tollivay Drive
ROLLING MEADOWS, IL 60008
Tel: (312) 255-9800
Telex: 910-687-1066
A,CH,CM,CS,E,MP

Indiana

Hewlett-Packard Co.
P.O. Box 50807
7301 No. Shadeland Avenue
INDIANAPOLIS, IN 46250
Tel: (317) 842-1000
A,CH,CM,CS,E,MS

Iowa

Hewlett-Packard Co.
1776 22nd Street, Suite 1
WEST DES MOINES, IA 50262
Tel: (515) 224-1435
CH,MS**
Hewlett-Packard Co.
2415 Heinz Road
IOWA CITY, IA 52240
Tel: (319) 351-1020
CH,E*,MS

Kansas

Hewlett-Packard Co.
7804 East Funston Road
Suite 203
WICHITA, KA 67207
Tel: (316) 684-8491
CH

Kentucky

Hewlett-Packard Co.
10300 Linn Station Road
Suite 100
LOUISVILLE, KY 40223
Tel: (502) 426-0100
A,CH,CS,MS

Louisiana

Hewlett-Packard Co.
P.O. Box 1449
KENNER, LA 70063
160 James Drive East
ST. ROSE, LA 70087
Tel: (504) 467-4100
A,CH,CS,E,MS

Maryland

Hewlett-Packard Co.
3701 Koppers Street
BALTIMORE, Md. 21227
Tel: (301) 644-5800
Telex: 710-862-1943
A,CH,CM,CS,E,MS
Hewlett-Packard Co.
2 Choke Cherry Road
ROCKVILLE, MD 20850
Tel: (301) 948-6370
A,CH,CM,CS,E,MP

Massachusetts

Hewlett-Packard Co.
32 Hartwell Avenue
LEXINGTON, MA 02173
Tel: (617) 861-8960
A,CH,CM,CS,E,MP

Michigan

Hewlett-Packard Co.
23855 Research Drive
FARMINGTON HILLS, MI 48024
Tel: (313) 476-6400
A,CH,CM,CS,E,MP

Hewlett-Packard Co.
4326 Cascade Road S.E.
GRAND RAPIDS, MI 49506
Tel: (616) 957-1970
CH,CS,MS

Hewlett-Packard Co.
1771 W. Big Beaver Road
TROY, MI 48084
Tel: (313) 643-6474
CH,CS

Minnesota

Hewlett-Packard Co.
2025 W. Larpenteur Ave.
ST. PAUL, MN 55113
Tel: (612) 644-1100
A,CH,CM,CS,E,MP

Missouri

Hewlett-Packard Co.
11131 Colorado Avenue
KANSAS CITY, MO 64137
Tel: (816) 763-8000
A,CH,CM,CS,E,MS
Hewlett-Packard Co.
13001 Hollenberg Drive
BRIDGETON, MO 63044
Tel: (314) 344-5100
A,CH,CS,E,MP

Nebraska

Hewlett-Packard
10824 Old Mill Rd., Suite 3
OMAHA, NE 68154
Tel: (402) 334-1813
CM,MS

New Jersey

Hewlett-Packard Co.
W120 Century Road
PARAMUS, NJ 07652
Tel: (201) 265-5000
A,CH,CM,CS,E,MP
Hewlett-Packard Co.
60 New England Av. West
PISCATAWAY, NJ 08854
Tel: (201) 981-1199
A,CH,CM,CS,E

New Mexico

Hewlett-Packard Co.
P.O. Box 11634 (87192)
11300 Lomas Blvd.,N.E.
ALBUQUERQUE, NM 87112
Tel: (505) 292-1330
CH,CS,E,MS

New York

Hewlett-Packard Co.
Computer Drive South
ALBANY, NY 12205
Tel: (518) 458-1550
Telex: 710-444-4691
A,CH,E,MS
Hewlett-Packard Co.
P.O. Box AC
9600 Main Street
CLARENCE, NY 14031
Tel: (716) 759-8621
CH

Hewlett-Packard Co.
200 Cross Keys Office Park
FAIRPORT, NY 14450
Tel: (716) 223-9950
CH,CM,CS,E,MS

Hewlett-Packard Co.
7641 Henry Clay Blvd.
LIVERPOOL, NY 13088
Tel: (315) 451-1820
A,CH,CM,E,MS

Hewlett-Packard Co.
No. 1 Pennsylvania Plaza
55th Floor
34th Street & 8th Avenue
MANHATTAN NY 10001
Tel: (212) 971-0800
CH,CS,E*,M*

Hewlett-Packard Co.
250 Westchester Avenue
WHITE PLAINS, NY 10604
Tel: (914) 328-0884
CM,CH,CS,E

Hewlett-Packard Co.
3 Crossways Park West
WOODBURY, NY 11797
Tel: (516) 921-0300
Telex: 510-221-2183
A,CH,CM,CS,E,MS



SALES & SUPPORT OFFICES

Arranged alphabetically by country

UNITED STATES (Cont'd) Texas

North Carolina
Hewlett-Packard Co.
P.O. Box 26500 (27420)
5605 Roanne Way
GREENSBORO, NC 27409
Tel: (919) 852-1800
A,CH,CM,CS,E,MS

Ohio
Hewlett-Packard Co.
9920 Carver Road
CINCINNATI, OH 45242
Tel: (513) 891-9870
CH,CS,MS

Hewlett-Packard Co.
16500 Sprague Road
CLEVELAND, OH 44130
Tel: (216) 243-7300
A,CH,CM,CS,E,MS

Hewlett-Packard Co.
962 Crupper Ave.
COLUMBUS, OH 43229
Tel: (614) 436-1041
CH,CM,CS,E*

Hewlett-Packard Co.
P.O. Box 280
330 Progress Rd.
DAYTON, OH 45449
Tel: (513) 859-8202
A,CH,CM,E*,MS

Oklahoma
Hewlett-Packard Co.
P.O. Box 75609 (73147)
304 N. Meridian, Suite A
3
OKLAHOMA CITY, OK 73107
Tel: (405) 946-9499
A*,CH,E*,MS

Hewlett-Packard Co.
3840 S. 103rd E. Avenue
Logan Building, Suite 100
TULSA, OK 74145
Tel: (918) 665-3300
A** ,CH,CS,M*

Oregon
Hewlett-Packard Co.
9255 S. W. Pioneer Court
WILSONVILLE, OR 97070
Tel: (503) 682-8000
A,CH,CS,E*,MS

Pennsylvania
Hewlett-Packard Co.
1021 8th Avenue
KING OF PRUSSIA, PA 19046
Tel: (215) 265-7000
A,CH,CM,CS,E,MP

Hewlett-Packard Co.
111 Zeta Drive
PITTSBURGH, PA 15238
Tel: (412) 782-0400
A,CH,CS,E,MP

South Carolina
Hewlett-Packard Co.
P.O. Box 21708 (29221)
Brookside Park, Suite 122
1 Harbison Way
COLUMBIA, SC 29210
Tel: (803) 732-0400
CH,E,MS

Tennessee
Hewlett-Packard Co.
3070 Directors Row
MEMPHIS, TN 38131
Tel: (901) 346-8370
A,CH,MS

Hewlett-Packard Co.
Suite C-110
4171 North Mesa
EL PASO, TX 79902
Tel: (915) 533-3555
CH,E*,MS**

Hewlett-Packard Co.
P.O. Box 42816 (77042)
10535 Harwin Street
HOUSTON, TX 77036
Tel: (713) 776-6400
A,CH,CM,CS,E,MP

Hewlett-Packard Co.
P.O. Box 1270
930 E. Campbell Rd.
RICHARDSON, TX 75080
Tel: (214) 231-6101
A,CH,CM,CS,E,MP

Hewlett-Packard Co.
P.O. Box 32993 (78216)
1020 Central Parkway South
SAN ANTONIO, TX 78232
Tel: (512) 494-9336
CH,CS,E,MS

Utah
Hewlett-Packard Co.
P.O. Box 26626 (84126)
3530 W. 2100 South
SALT LAKE CITY, UT 84119
Tel: (801) 974-1700
A,CH,CS,E,MS

Virginia
Hewlett-Packard Co.
P.O. Box 9669 (23228)
RICHMOND, Va. 23228
4305 Cox Road
GLEN ALLEN, Va. 23060
Tel: (804) 747-7750
A,CH,CS,E,MS

Washington
Hewlett-Packard Co.
15815 S.E. 37th Street
BELLEVUE, WA 98006
Tel: (206) 643-4000
A,CH,CM,CS,E,MP
Hewlett-Packard Co.
Suite A
708 North Argonne Road
SPOKANE, WA 99206
Tel: (509) 922-7000
CH,CS

West Virginia
Hewlett-Packard Co.
P.O. Box 4297
4604 MacCorkle Ave., S.E.
CHARLESTON, WV 25304
Tel: (304) 925-0492
A,MS

Wisconsin
Hewlett-Packard Co.
150 S. Sunny Slope Road
BROOKFIELD, WI 53005
Tel: (414) 784-8800
A,CH,CS,E*,MP

URUGUAY
Pablo Ferrando S.A.C. e I.
Avenida Italia 2877
Casilla de Correo 370
MONTEVIDEO
Tel: 80-2586
Telex: Public Booth 901
A,CM,E,M

VENEZUELA
Hewlett-Packard de Venezuela C.A.
3A Transversal Los Ruices Norte
Edificio Segre
Apartado 50933
CARACAS 1071
Tel: 239-4133
Telex: 25146 HEWPACK
A,CH,CS,E,MS,P
Hewlett-Packard de Venezuela C.A.
Calle-72-Entre 3H Y 3Y, No.3H-40
Edificio Ada-Evelyn, Local B
Apartado 2646
MARACAIBO, Estado Zulia
Tel: (061) 80.304
C,E*

Hewlett-Packard de Venezuela C.A.
Calle Vargas Rondon
Edificio Seguros Carabobo, Piso 10
VALENCIA
Tel: (041) 51 385
CH,CS,P
Colimodio S.A.
Este 2 - Sur 21 No. 148
Apartado 1053
CARACAS 1010
Tel: 571-3511
Telex: 21529 COLMODIO
M

ZIMBABWE
Field Technical Sales
45 Kelvin Road, North
P.B. 3458
SALISBURY
Tel: 705 231
Telex: 4-122 RH
C,E,M,P

HEADQUARTERS OFFICES
If there is no sales office listed for your area, contact one of these headquarters offices.

NORTH/CENTRAL AFRICA
Hewlett-Packard S.A.
7 Rue du Bois-du-Lan
CH-1217 MEYRIN 1, Switzerland
Tel: (022) 83 12 12
Telex: 27835 hpse
Cable: HEWPACKSA Geneve

ASIA
Hewlett-Packard Asia Ltd.
6th Floor, Sun Hung Kai Centre
30 Harbour Rd.
G.P.O. Box 795
HONG KONG
Tel: 5-832 3211
Telex: 66678 HEWPA HX
Cable: HEWPACK HONG KONG

CANADA
Hewlett-Packard (Canada) Ltd.
6877 Goreway Drive
MISSISSAUGA, Ontario L4V 1M8
Tel: (416) 678-9430
Telex: 610-492-4246

EASTERN EUROPE
Hewlett-Packard Ges.m.b.h.
Liebiggasse 1
P.O.Box 72
A-1222 VIENNA, Austria
Tel: (222) 2365110
Telex: 1 3 4425 HEPA A

NORTHERN EUROPE
Hewlett-Packard S.A.
Uilenstede 475
NL-1183 AG AMSTELVEEN
The Netherlands
P.O.Box 999
NL-1180 AZ AMSTELVEEN
The Netherlands
Tel: 20 437771

OTHER EUROPE
Hewlett-Packard S.A.
7 rue du Bois-du-Lan
CH-1217 MEYRIN 1, Switzerland
Tel: (022) 83 12 12
Telex: 27835 hpse
Cable: HEWPACKSA Geneve

MEDITERRANEAN AND MIDDLE EAST
Hewlett-Packard S.A.
Mediterranean and Middle East Operations
Atrina Centre
32 Kifissias Ave.
Maroussi, ATHENS, Greece
Tel: 682 88 11
Telex: 21-6588 HPAT GR
Cable: HEWPACKSA Athens

EASTERN USA
Hewlett-Packard Co.
4 Choke Cherry Road
Rockville, MD 20850
Tel: (301) 258-2000

MIDWESTERN USA
Hewlett-Packard Co.
5201 Tollview Drive
ROLLING MEADOWS, IL 60008
Tel: (312) 255-9800

SOUTHERN USA
Hewlett-Packard Co.
P.O. Box 105005
450 Interstate N. Parkway
ATLANTA, GA 30339
Tel: (404) 955-1500

WESTERN USA
Hewlett-Packard Co.
3939 Lankershim Blvd.
LOS ANGELES, CA 91604
Tel: (213) 877-1282

OTHER INTERNATIONAL AREAS
Hewlett-Packard Co.
Intercontinental Headquarters
3495 Deer Creek Road
PALO ALTO, CA 94304
Tel: (415) 857-1501
Telex: 034-8300
Cable: HEWPACK

March 1983 5952-6900

HP distributors are printed in italics.

